

VON DUPRIN®

22 Series

Exit device



Introduction

Built to protect

Von Duprin® products symbolize a commitment to safety and security. It's evident in the meticulous engineering behind every exit device. After all, keeping our customers—and the people they strive to protect—safe is our priority. It's why Von Duprin goes the extra mile to provide durable and dependable products for every application.

The 22 Series is a cost-effective solution for medium to low traffic areas where proven reliability is needed. The non-handed design of the 22 Series makes it more adaptable in the field. And unique features set the series apart, including the Breakaway™ lever for protection against vandalism and the AX option that is UL certified to meet ADA and California Building Code requirements for 5 lb. operating force.

Passion driving performance

With superior products comes exceptional customer care. Von Duprin customers are supported by industry-leading expertise. Allegion's representatives average more than 15 years of experience, so you're assured to receive knowledgeable advice on fire and life safety codes, installation resources and more. And for those looking to take their skills to the next level, Allegion offers instructor-led workshops, videos and online courses. It's another way Von Duprin stands by our customers—today, tomorrow and for years to come.

VON DUPRIN
Administrative offices
2720 Tobey Dr.
Indianapolis, IN 46219

Customer service
877-671-7011
800-999-0328 - Fax

Technical support
877-671-7011

Table of contents

Exit hardware

Rim devices

22	8
22 Trim	9

Surface mounted

Vertical rod devices

2227	12
2227 Trim	13

Fire hardware

Rim devices

22-F	10
22-F Trim	11

Surface mounted

Vertical rod devices

2227-F	14
2227-F Trim	15



Options and accessories

Applications & trim operation	Double door applications Door handing Outside trim operation Lever styles
Trim selection	Optional trim Lever designs Operation options
Strike options/ Stile information	Strikes Stiles

Electrical accessories	ALK – Alarm kit LX – Latch bolt monitoring RX – Request to exit RX2 – Double request to exit CON – Allegion Connect
Mechanical options	LBR – Less bottom rod LD – Less dogging PL – Pullman latch AX – Accessible device
Device accessories	Cover plate kit Cylinders EPT – Electrical power transfer GBK – Glass bead kit PS902 – Alarm kit power supply Rod and latch guards
Additional information	ANSI Function, grade & type Device, latch and rod dimensions UL fire labeling and opening size How-to-order information Popular double door applications Nomenclature
Finishes	Standard finishes

Symbols



Indicates fire rated application



Indicates ADA products

Nomenclature – how to order

LD	Less dogging	RX	22	27	L	F	SP28	RHR	06	ALK	3'
LX	Latchbolt monitor switch										
LXLC	Latchbolt monitor switch, low current										
RX	Request to exit										
RXLC	Request to exit, low current										
RX2	Double request to exit										
AX	Accessible device										
22 22 Series											
None	Rim device										
27	Surface mounted vertical rod device										
DT	Dummy trim										
EO	Exit only										
K	Knob (Classroom)										
K-BE	Knob - blank escutcheon										
L	Lever (Classroom) (L-NL not available)										
L-BE	Lever - blank escutcheon (Passage)										
NL	Night latch (Key retracts latchbolt)										
NL-OP	Night latch cylinder assembly, optional pull										
TP	Thumbpiece										
TP-BE	Thumbpiece - blank escutcheon (Passage)										
None	Panic exit device										
F	Fire exit device										
Finishes	SP28, SP313										
LHR	Left hand reverse										
RHR	Right hand reverse										
XX	06 (Standard) 03 17										
LBR	Less bottom rod										
SNB	Sexbolts										
ALK	Alarm kit										
GBK	Glass bead kit										
CYL	Cylinder										
PL	Pullman latch										
SEC	Security screws										
	Optional trim										
	Optional strike										
CON	Allegion Connect										
Door width	3' (Standard), advise if different Only available up to 48"										
Door height	7' (Standard), advise if different										
Door thickness	1¾" (Standard), up to 2 1/4"										
Door/frame material											
HM	Hollow metal (standard)										
WD	Wood (standard)										
AL	Aluminum										
Device ctr. Line	See specifications, advise if different than standard										
Door applicaion											
SGL	Single (standard for rim)										
PR	Pair (standard for surface vertical)										
DE	Double egress (surface vertical)										
Door listing	3 Hour 1½ Hour 1 Hour 45 Minute 20 Minute										

Popular double door applications

Double door applications

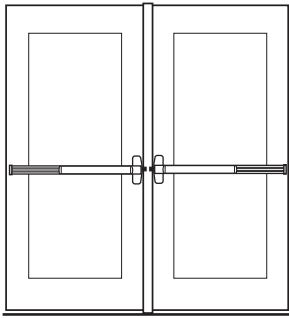

Two rim devices with mullion—same direction, panic or fire device

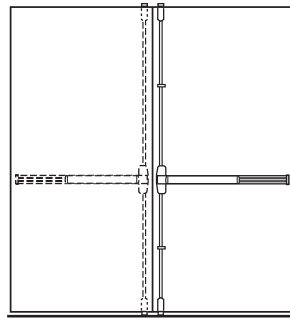

Two vertical rods—double egress, panic or fire device (LBR-F device can be used on double-egress)

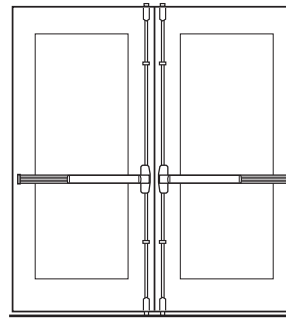

Two surface mounted vertical rod devices—same direction (do not use with overlapping astragal)

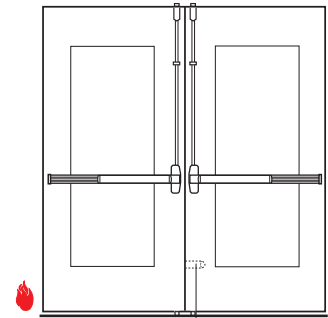

Two FEH vertical rods with auxiliary fire pin-LBR option (Don't use overlapping astragal on pair swinging same direction)

Door handing

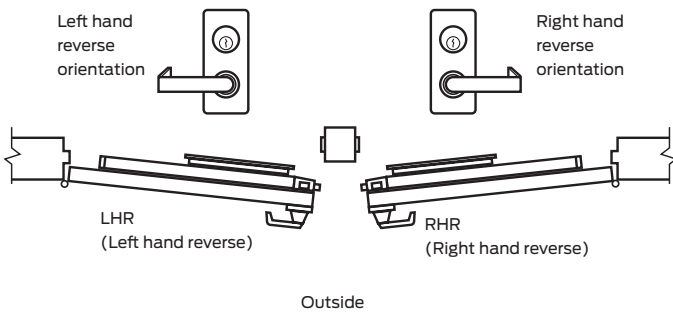

Outside trim operation

Standard trim

Features

- Bi directional lever rotation
- Field reversible handing

Lever trim operation



Standard operation
Key locks and unlocks lever.



Blank escutcheon
Lever always active. BE suffix, e.g., 230L-BE.

Lever styles

Standard levers



03



06
Default lever



17

22 Rim exit device



22 Rim exit device for all types of single and double doors with mullion, UL listed for Panic Exit Hardware. Devices are ANSI A156.3, 2008 Grade 1. Covers stock hollow metal doors with 161* cutouts. Fits door stiles as narrow as 3¹³/₁₆" (97 mm). The device is non-handed.

Finishes – SP28 & SP313.

*Not applicable with all strike and mullion combinations, consult factory.



The 299 Strike ships standard, optional strikes available

Hex key dogging comes standard on 22 Rim exit device



Specifications	
Device functions	Ships ready for all functions, EO, DT, NL, TP, K, L
Device lengths	3' (914 mm) see minimum door opening chart at bottom of page 4' (1219 mm) see minimum door opening chart at bottom of page
Device centerline from finished floor	39 ¹³ / ₁₆ " (1011 mm) 39 ¹¹ / ₁₆ " (1008 mm) with mullion
Center case dimensions	4 ¹ / ₄ " (108 mm) x 1 ³ / ₈ " (41 mm) x 2 ³ / ₈ " (60 mm)
Mechanism case dimensions	2" (51 mm) x 3 ³ / ₄ " (95 mm)
Projection push bar	Push bar neutral - 3 ³ / ₄ " (95 mm) push bar depressed - 3" (76 mm)
Latch bolt	Deadlocking, 3/4" (19 mm) throw
Fasteners & sex bolts (SNB)	Includes 1 ³ / ₄ " (44 mm) and 2 ¹ / ₄ " (57 mm) wood & metal doors optional SNB available for device
Electric options	LX latchbolt monitor switch RX pushpad monitor switch RX2 double pushpad monitor switch ALK alarm exit kit CON Allegion Connect
Mechanical options	GBK glass bead kit AX accessible device
Dogging feature	Hex key dogging standard
Dogging options	LD less dogging
Strikes	299 – Dull black

Minimum door opening chart

Stop height	Strike	Single door	Double door w/mullion	Minimum door opening for 3' device*	Minimum door opening w/ALK*
1/2"	299	Yes	—	26.500" (673mm)	33.250" (845mm)
1/2"	1439	Yes	—	25.687" (652mm)	32.437" (824mm)
1/2"	299	—	4754/4854/4954	27.000" (686mm)	33.750" (857mm)
1/2"	299	—	5654	25.812" (656mm)	32.562" (827mm)
1/2"	1408	—	5754	25.750" (679mm)	32.500" (826mm)
1/2"	1606	—	1654	26.562" (675mm)	33.312" (846mm)
5/8"	299	Yes	—	26.750" (679mm)	33.500" (851mm)
5/8"	1439	Yes	—	25.937" (659mm)	32.687" (830mm)
5/8"	299	—	4754/4854/4954	27.125" (689mm)	33.875" (860mm)
5/8"	299	—	5654	26.687" (678mm)	33.437" (849mm)
5/8"	1408	—	5754	25.875" (657mm)	32.625" (829mm)
5/8"	1606	—	1654	26.687" (678mm)	33.437" (849mm)

*For 4' device, add 6" (152mm)

AX

Accessible device

- UL certified to meet new 5 lb. maximum operating force requirement
- Exceeds ANSI/BHMA requirements

RX

Pushpad monitor switch

- Signals use of an opening
- SPDT switch to monitor pushpad

RX2

Double pushpad monitor switch

- Uses two RX switches

ALK

Alarm exit kit

- Unauthorized opening triggers 85-decibel horn
- Set in armed or disarmed mode by key

LX

Latchbolt monitor switch





- Signals use of opening
- SPDT Switch to monitor latchbolt

CON



Allegion Connectors

- Common connectors to connect various door hardware all the way to the power supply

Standard trim

	EO	DT	NL	NL-OP
				
Product description	22EO	22DT	22NL	22NL-OP
Trim description	—	210DT*	210NL*	110NL-MD* 110NL-WD*
Escutcheon plate size	—	5 ³ / ₈ " x 4 ²⁵ / ₃₂ " x 3 ³ / ₃₂ " (137 x 121 x 2 mm)	5 ³ / ₈ " x 4 ²⁵ / ₃₂ " x 3 ³ / ₃₂ " (137 x 121 x 2 mm)	—
Pull center to center	—	—	—	—
Projection	—	1 ³¹ / ₃₂ " (42 mm)	1 ³¹ / ₃₂ " (42 mm)	—
ANSI function	01	02	03	03
Cylinder type	—	—	Rim	Rim
Handing	—	—	—	—
Optional trim	230EO	230DT	230NL	—
Optional #425 sex bolt quantity for device	6 (with no trim) 2 (with EO trim)	2	2	6

*ANSI/BHMA A156.3 (2001) Grade 1 trim

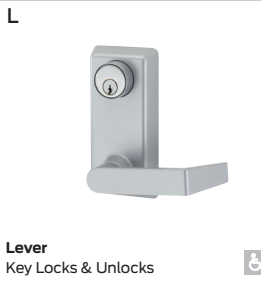
	TP	K	L
			
Product description	22TP	22K	22L
Trim description	230TP*	210K	230L*
Escutcheon plate size	3" x 12 ¹ / ₁₆ " x 3 ³ / ₃₂ " (76 x 306 x 2 mm)	3" x 4 ²⁵ / ₃₂ " x 3 ³ / ₃₂ " (76 x 121 x 2 mm)	3" x 6 ³ / ₈ " x 1 ⁵ / ₁₆ " (76 x 162 x 24 mm)
Pull center to center	5 ¹ / ₂ " (140 mm)	—	—
Projection	2" (51 mm)	2 ¹⁵ / ₁₆ " (75 mm)	2 ⁵ / ₈ " (67 mm)
ANSI function	05	08	08
Cylinder type	1 ¹ / ₄ " Mortise	Furnished	1 ¹ / ₄ " Mortise
Handing	—	—	—
Optional trim	230TP-BE	210K-BE	230L-BE
Optional #425 sex bolt quantity for device	2	2	2

*ANSI/BHMA A156.3 (2008) Grade 1 trim

22-F Rim fire exit device



22-F Rim fire exit devices for all types of single doors up to 4' x 8' (1219 mm x 2438 mm) or 8' x 8' (2438 mm x 2438 mm) double doors with 9954 or 9854 mullion, UL listed for Fire Exit Hardware. Devices are ANSI A156.3 – 2008 Grade 1. Fits door stiles as narrow as 4³/₈" (111 mm). The device is non-handed.

Finishes – SP28 & SP313.

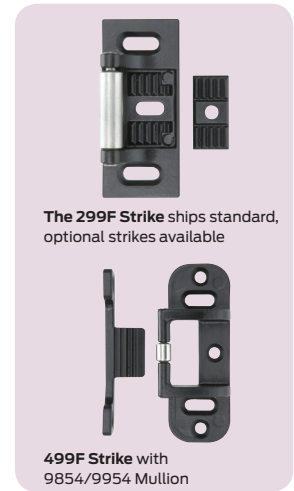

Specifications

Device functions	Ships ready for all functions, EO, DT, NL, TP, K, L
Device lengths	3' (914 mm) see minimum door opening chart at bottom of page 4' (1219 mm) see minimum door opening chart at bottom of page
Device centerline from finished floor	39 ¹³ / ₁₆ " (1011 mm) 39 ¹¹ / ₁₆ " (1008 mm) with mullion
Center case dimensions	4 ¹ / ₄ " (108 mm) x 1 ³ / ₈ " (41 mm) x 2 ³ / ₈ " (60 mm)
Mechanism case dimensions	2" (51 mm) x 3 ³ / ₄ " (95 mm)
Projection push bar	Push bar neutral - 3 ³ / ₄ " (95 mm) Push bar depressed - 3" (76 mm)
Latch bolt	Deadlocking, 3/4" (19mm) throw
Fasteners & Sex bolts (SNB)	Includes 1 ³ / ₄ " (44 mm) and 2 ¹ / ₄ " (57 mm) wood & metal doors Optional SNB available for device (see next page for quantities)
Electric options	LX latchbolt monitor switch RX pushpad monitor switch RX2 double pushpad monitor switch ALK alarm exit kit CON Allegion Connect
Mechanical options	GBK glass bead kit AX accessible device
Dogging feature	No mechanical dogging
Strikes	299F, 499F for mullions – Dull black

AX

Accessible device

- UL certified to meet new 5 lb. maximum operating force requirement
- Exceeds ANSI/BHMA requirements

RX

Pushpad monitor switch

- Signals use of an opening
- SPDT switch to monitor pushpad

RX2

Double pushpad monitor switch

- Uses two RX switches

ALK

Alarm exit kit

- Unauthorized opening triggers 85-decibel horn
- Set in armed or disarmed mode by key

CON

Allegion Connectors

- Common connectors to connect various door hardware all the way to the power supply

LX

Latchbolt monitor switch



- Signals use of opening
- SPDT Switch to monitor latchbolt

Minimum door opening chart

Stop height	Strike	Single door	Double door w/mullion	Minimum door opening for 3' device*	Minimum door opening w/ALK*
1/2"	299F/499F	Yes	—	26.500" (673 mm)	33.250" (845 mm)
1/2"	299F/499F	—	KR/9854/9954	27.000" (686 mm)	33.750" (857 mm)
5/8"	299F/499F	Yes	—	26.750" (679 mm)	33.500" (851mm)
5/8"	299F/499F	—	KR/9854/9954	27.125" (689 mm)	33.875" (860 mm)



*For 4' device, add 6" (152 mm)

Standard trim

	EO	NL	NL-OP
			
Product description	22EO-F	22NL-F	22NL-OP-F
Trim description	—	210NL**	110NL-MD** 110NL-WD**
Escutcheon plate size	—	5 ³ / ₈ " x 4 ²⁵ / ₃₂ " x 3 ³ / ₃₂ " (137 x 121 x 2 mm)	—
Pull center to center	—	—	—
Projection	—	1 ³¹ / ₃₂ " (42 mm)	—
ANSI function	01	03	03
Cylinder type	—	Rim	Rim
Handing	—	—	—
Optional trim	230EO	230NL	—
*Optional #425 sex bolt quantity for device	6 (with no trim) 2 (with EO trim)	2	6
*Additional 425 SNB for 499F strike	2	2	2

*Sex Bolts are required for wood fire doors

**ANSI/BHMA A156.3 (2008) Grade 1 trim

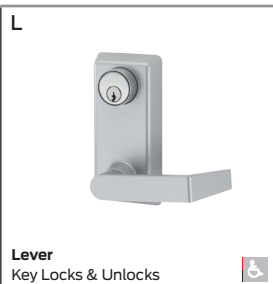
	TP	K	L
			
Product description	22TP-F	22K-F	22L-F
Trim description	230TP**	210K	230L**
Escutcheon plate size	3" x 12 ¹ / ₁₆ " x 3 ³ / ₃₂ " (76 x 306 x 2 mm)	3" x 4 ²⁵ / ₃₂ " x 3 ³ / ₃₂ " (76 x 121 x 2 mm)	3" x 6 ³ / ₈ " x 1 ⁵ / ₁₆ " (76 x 162 x 24 mm)
Pull center to center	5 ¹ / ₂ " (140 mm)	—	—
Projection	2" (51 mm)	2 ¹⁵ / ₁₆ " (75 mm)	2 ⁵ / ₈ " (67 mm)
ANSI function	05	08	08
Cylinder type	1 ¹ / ₄ " Mortise	Furnished	1 ¹ / ₄ " Mortise
Handing	—	—	—
Optional trim	230TP-BE	210K-BE	230L-BE
*Optional #425 sex bolt quantity for device	2	2	2
*Additional 425 SNB for 499F strike	2	2	2

*Sex Bolts are required for wood fire doors

**ANSI/BHMA A156.3 (2008) Grade 1 trim



2227 Surface mounted vertical rod device



2227 Surface mounted vertical rod exit device for all types of single and double doors, UL listed for Panic Exit Hardware. Devices are ANSI A156.3 – 2008 Grade 1. Covers stock hollow metal doors with 86 or 161 cutouts. Fits door stiles as narrow as 3⁵/₈" (92 mm). The device is non-handed.

Finishes – SP28 & SP313.



Hex key dogging comes standard on 2227 Surface mounted vertical rod device



Specifications

Device functions	Ships ready for all functions, EO, DT, NL, TP, K, L
Device lengths	3' (914 mm) see minimum door opening chart at bottom of page 4' (1219 mm) see minimum door opening chart at bottom of page
Door height	7' (2134 mm) standard door height extension rods available for door heights up to 10' (3048mm) 12" (205 mm), door height 36" (914 mm), door height
Device centerline from finished floor	39 ¹³ / ₁₆ " (1011 mm)
Center case dimensions	4 ¹ / ₄ " (108 mm) x 1 ³ / ₈ " (41 mm) x 2 ³ / ₈ " (60 mm)
Mechanism case dimensions	2" (51 mm) x 3 ³ / ₄ " (95 mm)
Projection push bar	Push bar neutral - 3 ³ / ₄ " (95 mm) Push bar depressed - 3" (76 mm)
Door undercut	1 ¹ / ₄ " (7 mm) from finished floor recommended, 3 ³ / ₄ " (19mm) maximum or 1 ¹ / ₈ " (3mm) from threshold
Latch bolt	Deadlocking anti-friction top and bottom bolt, 5 ⁵ / ₈ " (16 mm) throw
Fasteners & sex bolts (SNB)	Includes 1 ³ / ₄ " (44 mm) and 2 ¹ / ₄ " (57 mm) wood & metal doors. Optional SNB available for device.
Electric options	LX latchbolt monitor switch RX pushpad monitor switch RX2 double pushpad monitor switch ALK alarm exit kit CON Allegion Connect
Mechanical options	PL pullman latch GBK glass bead kit RG rod guards LG latch guards
Dogging feature	Hex key dogging standard
Dogging options	LD less dogging
Strikes	299 – Dull black Bottom 248L-4 and 304L – unfinished

LX
Latchbolt monitor switch

- Signals use of opening
- SPDT Switch to monitor latchbolt

RX
Pushpad monitor switch

- Signals use of an opening
- SPDT switch to monitor pushpad

RX2
Double pushpad monitor switch

- Uses two RX switches

ALK
Alarm exit kit

- Unauthorized opening triggers 85-decibel horn
- Set in armed or disarmed mode by key

CON
Allegion Connectors





- Common connectors to connect various door hardware all the way to the power supply

Minimum door opening chart



Stop height	Strike	Single door	Double door w/mullion	Minimum door opening for 3' device*	Minimum door opening w/ALK*
1/2"	N/A	Yes	Vert. x Vert.	25.875" (657 mm)	32.625" (829 mm)
5/8"	N/A	Yes	Vert. x Vert.	26.000" (664 mm)	32.750" (832 mm)

*For 4' device, add 6" (152 mm)

Standard trim

	EO	DT	NL	NL-OP
				
Product description	2227EO	2227DT	2227NL	2227NL-OP
Trim description	—	210DT*	210NL*	110NL-MD* 110NL-WD*
Escutcheon plate size	—	5 ³ / ₈ " x 4 ²⁵ / ₃₂ " x 3 ³ / ₃₂ " (137 x 121 x 2 mm)	5 ³ / ₈ " x 4 ²⁵ / ₃₂ " x 3 ³ / ₃₂ " (137 x 121 x 2 mm)	—
Pull center to center	—	—	—	—
Projection	—	1 ³¹ / ₃₂ " (42 mm)	1 ³¹ / ₃₂ " (42 mm)	—
ANSI function	01	02	03	03
Cylinder type	—	—	Rim	Rim
Handing	—	—	—	—
Optional trim	230EO	230DT	230NL	—
Optional #425 sex bolt quantity for device	6 (with no trim) 2 (with EO trim)	2	2	6

*ANSI/BHMA A156.3 (2008) Grade 1 trim

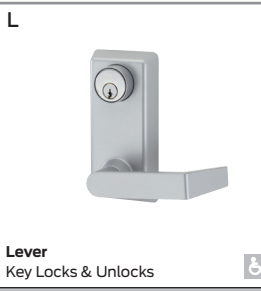
	TP	K	L
			
Product description	2227TP	2227K	2227L
Trim description	230TP*	210K	230L*
Escutcheon plate size	3" x 12 ¹ / ₁₆ " x 3 ³ / ₃₂ " (76 x 306 x 2 mm)	3" x 4 ²⁵ / ₃₂ " x 3 ³ / ₃₂ " (76 x 121 x 2 mm)	3" x 6 ³ / ₈ " x 1 ⁵ / ₁₆ " (76 x 162 x 24 mm)
Pull center to center	5 ¹ / ₂ " (140 mm)	—	—
Projection	2" (51 mm)	2 ¹⁵ / ₁₆ " (75 mm)	2 ⁵ / ₈ " (67 mm)
ANSI function	05	08	08
Cylinder type	1 ¹ / ₄ " Mortise	Furnished	1 ¹ / ₄ " Mortise
Handing	—	—	—
Optional trim	230TP-BE	210K-BE	230L-BE
Optional #425 sex bolt quantity for device	2	2	2

*ANSI/BHMA A156.3 (2008) Grade 1 trim

2227-F Surface mounted vertical rod fire exit device



2227-F Surface mounted vertical rod fire exit device for pairs of doors up to 8' x 10' (2438 mm x 3048 mm), UL listed for Fire Exit Hardware. Devices are ANSI A156.3 – 2008 Grade 1. Fits door stiles as narrow as 3 5/8" (92 mm). See opposite page for available outside trim and device functions. The device is non-handed.

Finishes – SP28 & SP313.



Specifications

Device functions	Ships ready for all functions, EO, DT, NL, TP, K, L
Device lengths	3' (914 mm) see minimum door opening chart at bottom of page 4' (1219 mm) see minimum door opening chart at bottom of page
Door height	7' (2134 mm) standard door height extension rods available for door heights up to 10' (3048mm) 12" (205 mm), door height 36" (914 mm), door height
Device centerline from finished floor	39 13/16" (1011 mm)
Center case dimensions	4 1/4" (108 mm) x 1 3/8" (41 mm) x 2 3/8" (60 mm)
Mechanism case dimensions	2" (51 mm) x 3 3/4" (95 mm)
Projection push bar	Push bar neutral - 3 3/4" (95 mm) Push bar depressed - 3" (76 mm)
Door undercut	1/4" (7 mm) from finished floor recommended
Latch bolt	Deadlocking anti-friction top and bottom bolt, 5/8" (16 mm) throw
Fasteners & sex bolts (SNB)	Includes 1 3/4" (44 mm) and 2 1/4" (57 mm) wood & metal doors. Optional SNB available for device.
Electric options	LX latchbolt monitor switch RX pushpad monitor switch RX2 double pushpad monitor switch ALK alarm exit kit CON Allegion Connect
Mechanical options	PL pullman latch GBK glass bead kit RG rod guards LG latch guards
Dogging feature	No mechanical dogging
Strikes	Top 299F – (499F LBR) – Dull black Bottom 304L – Unfinished

Minimum door opening chart

Stop height	Strike	Single door	Double door w/mullion	Minimum door opening for 3' device*	Minimum door opening w/ALK*
1/2"	N/A	Yes	Vert. x Vert.	25.875" (657 mm)	32.625" (829 mm)
5/8"	N/A	Yes	Vert. x Vert.	26.000" (664 mm)	32.750" (832 mm)

*For 4' device, add 6" (152 mm)

RX

Pushpad monitor switch

- Signals use of an opening
- SPDT switch to monitor pushpad

RX2

Double pushpad monitor switch

- Uses two RX switches

ALK

Alarm exit kit

- Unauthorized opening triggers 85-decibel horn
- Set in armed or disarmed mode by key

CON

Allegion Connectors



- Common connectors to connect various door hardware all the way to the power supply

LX

Latchbolt monitor switch

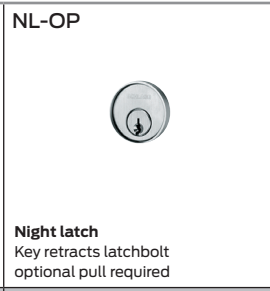

- Signals use of opening
- SPDT Switch to monitor latchbolt

Standard trim

	EO	NL	NL-OP
			
Product description	2227EO-F	2227NL-F	2227NL-OP-F
Trim description	—	210NL**	110NL-MD** 110NL-WD**
Escutcheon plate size	—	5 ³ / ₈ " x 4 ²⁵ / ₃₂ " x 3 ³ / ₃₂ " (137 x 121 x 2 mm)	—
Pull center to center	—	—	—
Projection	—	1 ³¹ / ₃₂ " (42 mm)	—
ANSI function	01	03	03
Cylinder type	—	Rim	Rim
Handing	—	—	—
Optional trim	230EO	230NL	—
*Optional #425 sex bolt quantity for device	6 (with no trim) 2 (with EO trim)	2	6
*Additional 425 SNB for 499F strike	2	2	2

*Sex Bolts are required for wood fire doors

**ANSI/BHMA A156.3 (2008) Grade 1 trim

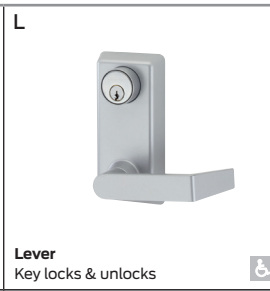
	TP	K	L
			
Product description	2227TP-F	2227K-F	2227L-F
Trim description	230TP**	210K	230L**
Escutcheon plate size	3" x 12 ¹ / ₁₆ " x 3 ³ / ₃₂ " (76 x 306 x 2 mm)	3" x 4 ²⁵ / ₃₂ " x 3 ³ / ₃₂ " (76 x 121 x 2 mm)	3" x 6 ³ / ₈ " x 1 ⁵ / ₁₆ " (76 x 162 x 24 mm)
Pull center to center	5 ¹ / ₂ " (140 mm)	—	—
Projection	2" (51 mm)	2 ¹⁵ / ₁₆ " (75 mm)	2 ⁵ / ₈ " (67 mm)
ANSI function	05	08	08
Cylinder type	1 ¹ / ₄ " Mortise	Furnished	1 ¹ / ₄ " Mortise
Handing	—	—	—
Optional trim	230TP-BE	210K-BE	230L-BE
*Optional #425 sex bolt quantity for device	2	2	2
*Additional 425 SNB for 499F strike	2	2	2

*Sex Bolts are required for wood fire doors

**ANSI/BHMA A156.3 (2008) Grade 1 trim

22 Optional trim

210 Series trim







The 210DT and 210NL have a heavy 10 gauge (2.4mm) stainless steel escutcheon. Rim Cylinder must be ordered separately for the 210NL trim. The 210K knob trim has a 10 gauge (2.4mm) steel escutcheon and uses the Schlage "A" orbit knob with six pin "C" keyway.

110NL Cylinder kit

Cylinder kit is available MD for metal doors or WD for wood doors. Metal door application supplied standard if door material is not specified. When ordering with device, specify function NL-OP. Rim Cylinder must be ordered separately.

230 Series trim

The 230EO, 230DT, 230NL and 230TP have a heavy 10 gauge (2.4mm) steel escutcheon. The 230L has a cast zinc $\frac{3}{4}$ " (19mm) depth escutcheon. #06 lever style furnished standard, #03 and #17 optional style levers are available. 230L furnished RHR if handing is not specified. Cylinder must be ordered separately for the 230NL, 230TP and 230L trims.

	EO	DT	NL	TP-BE	L-BE	K-BE
						
	Exit only plate	Dummy trim pull when dogged	Night latch key retracts latch bolt	Thumbpiece blank escutcheon always operable, no cylinder	Lever blank escutcheon always operable, no cylinder	Knob blank escutcheon always operable, no cylinder
Trim description	230EO	230DT**	230NL**	230TP-BE**	230L-BE**	210K-BE
Escutcheon plate size	3" x 12 $\frac{1}{16}$ " x $\frac{3}{32}$ " (76 x 306 x 2 mm)	3" x 12 $\frac{1}{16}$ " x $\frac{3}{32}$ " (76 x 306 x 2 mm)	3" x 12 $\frac{1}{16}$ " x $\frac{3}{32}$ " (76 x 306 x 2 mm)	3" x 12 $\frac{1}{16}$ " x $\frac{3}{32}$ " (76 x 306 x 2 mm)	3" x 6 $\frac{3}{8}$ " x $\frac{15}{16}$ " (76 x 162 x 24 mm)	3" x 4 $\frac{25}{32}$ " x $\frac{3}{32}$ " (76 x 121 x 2 mm)
Pull center to center	—	5 $\frac{1}{2}$ " (140 mm)	5 $\frac{1}{2}$ " (140 mm)	5 $\frac{1}{2}$ " (140 mm)	—	—
Projection	—	2" (51 mm)	2" (51 mm)	2" (51 mm)	2 $\frac{3}{8}$ " (67 mm)	2 $\frac{15}{16}$ " (75 mm)
ANSI function	01	02	03	—	—	—
Cylinder type	—	—	Rim	—	—	—
*Optional #425 sex bolt quantity for device	2	2	6	—	2	2
*Additional 425 SNB for 499F strike	2	2	2	2	2	2

*Sex Bolts are required for wood fire doors
 **ANSI/BHMA A156.3 (2008) Grade 1 Trim

22 Strike/Stile information

Strikes for rim devices

<p>264</p> <p>Projection $\frac{9}{16}$" (14 mm)</p>	<p>299</p> <p>Projection $\frac{13}{16}$" (21 mm)</p>	<p>299F</p> <p>Projection $\frac{13}{16}$" (21 mm)</p>	<p>499F</p> <p>Projection $\frac{15}{16}$" (24 mm)</p>
<p>1408</p> <p>Used with 5754 Mullion One per pair of doors</p>	<p>1410—Integral Stop</p> <p>Projection $\frac{1}{2}$" (13 mm)</p>	<p>1439—Blade Stop***</p> <p>Projection $\frac{1}{2}$" (13 mm)</p>	<p>1606</p> <p>Projection $\frac{3}{8}$" (10 mm)</p>
<p>1609**</p> <p>(Not fire rated; requires coordinates)</p>			

Strikes for vertical rod devices

<p>248L-4</p> <p>Projection $\frac{3}{8}$" (10 mm)</p>	<p>260U—Flush transom only</p> <p>Projection $\frac{3}{8}$" (10 mm)</p>	<p>304L</p> <p>Mortise $\frac{13}{16}$" (21 mm)</p>	<p>385A</p> <p>Mortise $2\frac{1}{12}$" (64 mm)</p>
--	---	---	---

Strikes 264, 299, 299F and 499F also available for vertical rod devices.

Device type	Standard single door		Standard double door		OPTIONAL single door		OPTIONAL double door	
	Strike	Stile	Application*	Stile	Strike	Stile	Application*	Stile
22	299	$4\frac{3}{4}$ " (121 mm)	299 x 4954	$4\frac{3}{4}$ " (121 mm)	1439	$3\frac{3}{16}$ " (97 mm)	299 w/5654	$4\frac{1}{4}$ " (108 mm)
					1410	$3\frac{3}{16}$ " (97 mm)	1408 w/5754	$3\frac{3}{16}$ " (97 mm)
					1606	$3\frac{15}{16}$ " (100 mm)	1606 w/1654	$4\frac{1}{4}$ " (108 mm)
					—	—	1609 w/vertical rod**	$4\frac{3}{8}$ " (111 mm)
22-F	299F	$4\frac{3}{8}$ " (111 mm)	499F x 9954	$4\frac{7}{8}$ " (124 mm)	—	—	—	
2227 Latch Retraction	299 (Top) 299 (Middle) 304L/284-L (Bottom)	$3\frac{5}{8}$ " (92 mm)	Two Vertical Rods	$3\frac{5}{8}$ " (92 mm)	260U Top 385A Bottom	$3\frac{5}{8}$ " (92 mm)	Two Vertical Rods	$3\frac{5}{8}$ " (92 mm)
2227 Pullman Latch	299 (Top) 284-L (Bottom)	$3\frac{5}{8}$ " (92 mm)	Two Vertical Rods	$3\frac{5}{8}$ " (92 mm)	260U Top	$3\frac{5}{8}$ " (92 mm)	Two Vertical Rods	$3\frac{5}{8}$ " (92 mm)
2227-F	299 (Top) 304L (Bottom)	$3\frac{5}{8}$ " (92 mm)	Two Vertical Rods	$3\frac{5}{8}$ " (92 mm)	260U-SS	4"	4"	4"

*Mullion information, refer to General and Auxiliary Catalog.

**Not for UL Fire exit hardware. Must be used with a coordinator.

***Replaces 1409 Strike

Note: On a Rim/Vertical rod application for a pair of doors, the 1609 strike extends off the edge of the door into the opening.

22 Electrical options

Power supplies

PS902

Overview:

The PS902 is an AC power supply that provides 24 VDC power to operate the ALK alarm kit. The unit will power up to 6 alarm kits.

Note: PS902-BB provides power in case of an AC power failure.



EPT Electrical power transfer

Electric Power Transfer provides a means of transferring electrical power from a door frame to the edge of a swinging door. The units are completely concealed when the door is in the closed position, and are ideal for installations involving abuse or heavy traffic.

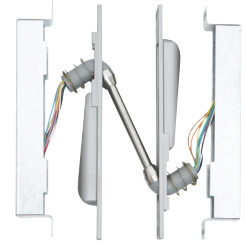

Two models are available; EPT-2, two 18 gauge wires and EPT-10, ten 24 gauge wires. The EPT-2 and EPT-10 are U/L listed as "miscellaneous door accessory".

UL Listed for use on fire doors.

Door applications:

Degree of opening	Hinge type	Door thickness
0-180	Up to 5" butt hinges	1 ³ / ₄ "
0-180	Up to ³ / ₄ " offset pivots	1 ³ / ₄ "
0-130	5 ¹ / ₂ " butt hinges	1 ³ / ₄ "
0-110	6" butt hinges	1 ³ / ₄ "
0-90	Swing clear hinges	1 ³ / ₄ "

Finishes

SP28 (sprayed aluminum)

SP313 (sprayed duranodic)

Dimensions

Housing	9" x 1 ¹ / ₄ " x 1 ⁵ / ₈ " (229mm x 32mm x 38mm)
EPT-2	Two 18 gauge wires, Up to 2 AMPS @ 24VDC, with a 16 AMPS Maximum Surge
EPT-10	Ten 24 gauge wires, Up to 1 AMPS @ 24VDC, with a 16 AMPS Maximum Surge

To order, specify:

1. EPT-2 or EPT-10.
2. Finish, SP28 or SP313.

22 Electrical options

RX Request to exit

The RX (Request to exit) feature is used to signal the use of an opening. This device is equipped with one internal SPDT switch which monitors the pushpad.



The device can be connected to a security console, or may be used as a single door alarm when used with a horn and power supply.

The RX switch option should not be used to control a load, but as a signalling switch (0.5 amps. resistive maximum).

The RX switch is available in a low current (LC) switch. Most commonly used in computer operated monitoring systems.

To order, specify:

- Standard – Use prefix RX, example RX22EO
- Low Current – Use prefix RX-LC, example RX-LC22EO

RX2 Double request to exit

The RX2 feature uses two RX switches.

To order, specify:

- Standard – Use prefix RX2, example RX22EO

LX Latchbolt monitoring



The LX feature is used to signal the use of an opening. This device is equipped with one internal SPDT switch which monitors the latch bolt.

The device can be connected to a security console, or may be used as a single door alarm when used with a horn and power supply.

The LX switch option should not be used to control a load, but as a signalling switch (0.5 amps. resistive maximum).

The LX switch is available in a low current (LC) switch. Most commonly used in computer operated monitoring systems.

To order, specify:

- Standard – use prefix LX, example LX22EO
- Low Current – use prefix LX-LC, example LX-LC22EO

Electrical rating for all switches:

- Standard – up to 0.5 Amp @ 24VDC Maximum
- Low Current (LC) - up to 0.5 Amp @ 24VDC Maximum

Note: All switches can be either factory or field installed

ALK Alarm kit

ALK Alarm Kit is a simple yet effective way to deter unauthorized use of an opening. While the exit device is still a means of egress, the ALK kit contains an internal horn. When the touch bar is depressed, the horn sounds to provide an audible means of signaling that the opening has been violated. The alarm kit can be armed or disarmed by key thus allowing the exit device to be set in an armed or disarmed mode. The horn is rated at 85 decibels.

For hardware applications

The assembly includes both a 24VDC Input and External Inhibit standard. The External Inhibit provides remote arming and disarming.

The key switch uses a standard 1-1/4" (32mm) mortise cylinder with a straight cam (Schlage 20-001, L583-477 cam). The unit operates on one standard 9-volt alkaline battery. When the battery is weak, the horn will emit an intermittent low battery alert signal.

Auto reset (AR) option is available with this kit. This kit allows the device to resume the alarm option after a preset time. Preset times can be field selected at 1.5, 3, or 4.5 minutes. Alarm kits are available with a choice of two switch kits, RX or LX. RX monitors the touchpad and is furnished standard. LX optional latch bolt monitoring is recommended for use with surface vertical rod exit devices or when alarm needs to sound from both the exit device and trim side of the door. Specify ALK-LX.

The ALK includes a 6" x 20" decal for application on door "EMERGENCY EXIT ONLY. ALARM WILL SOUND."

To order, specify:

1. Standard, 22 ALK

Minimum door opening sizes on ALK applications

Refer to device pages 8, 10, 12, and 14.

22 Electrical options

Allegion Connect

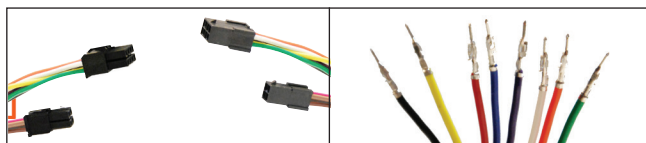

Allegion's cross-category Connect features common interconnect components to our electrified options. Allegion Connect is a quick and easy way to connect power sources; all the way from your power supply to locking device. There is no wire cutting; reducing installation and maintenance time ultimately cutting cost. After installation, Allegion's Connect continues to provide benefits throughout the lifetime of the opening by offering a service kit for repairs or modifications in the future.

Features and benefits

- Quick: common connections reducing installation time
- Perfect Connections: these factory installed connectors ensure the right wires match up every time
- Protective: the connectors protect the connection points throughout the installation process and lifetime of the opening
- Interchangeable: all Allegion Connect products utilize the same connectors
- Maintenance: you no longer need to cut away wire to disconnect Allegion products, also available is a service kit specifically for Connect products.

Harness length	Connectors on both ends	Connectors on one end, crimped pins on the other end
6 Inches	CON-6	CON-6P
12 Inches	CON-12	CON-12P
26 Inches	CON-26	CON-26P
32 Inches	CON-32	CON-32P
38 Inches	CON-38	CON-38P
44 Inches	CON-44	CON-44P
50 Inches	CON-50	CON-50P
192 Inches	CON-192	CON-192P

Power Supply Wire Harness = Connectors on one end, stripped leads on the other end, offering a direct connection to the power supply

6 Inches	CON-6W - wire extension to power supply
----------	---

Consult door manufacturer for harness length requirements.

Note: You will need to purchase a separate wiring harness to go from exit device to hinge/EPT and an additional harness to go from hinge/EPT to power supply or access control system. Harness part numbers with ordering information can be located in the Schlage, Von Duprin and Falcon pricebooks. A service kit is available for order in the Schlage, Von Duprin and Falcon pricebooks. Included in this kit are male end plugs, female end plugs and pins to customize harnesses to your application.

Note: Must be ordered with exit devices and locks

How to order

1. Specify CON for Connect electronic options
Example: RX-22-EO-CON (22 Series with RX switch and connectors).
2. Specify harness length; Consult door manufacturer for harness length
3. Specify Von Duprin EPT10-CON or Ives 7200 power transfer hinge

Wire run options

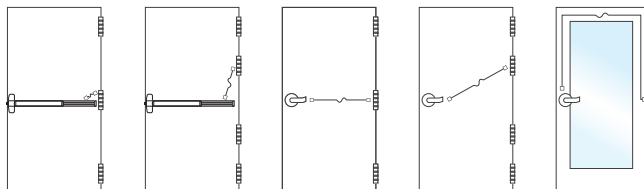

22 Options & accessories

AX Accessible device

The AX device is a UL certified exit device designed to meet the progressive requirements of the California Building Code for accessible openings. This device meets the 5 lbs of operating force requirement called for in chapter 11B-309.4. The AX device also exceeds ANSI/BHMA requirements. Available devices include: AX22 Series, AX22-F Series. Additionally, all AX devices will be shipped with a new UL label clearly stating "Meets California Building Code (2013) Sec. 11B-309.4" and an "AX" identifier label on device center case. See images below for reference.

Note: device shown below for reference is a 98 Series exit device.

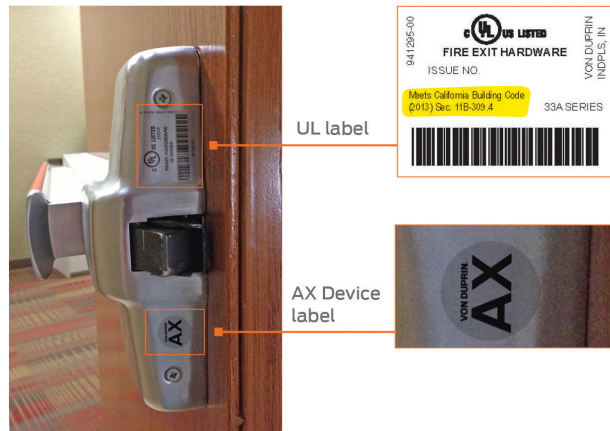

LBR Less bottom rod

LBR option for fire exit devices is available using a spring loaded auxiliary fire pin installed in the lower door edge. When exposed to heat the auxiliary fire pin releases, keeping the doors in alignment and closed during a fire.

LBR devices must be ordered in pairs of vertical rod devices, or must be used in conjunction with an approved automatic or constant latching flush bolt.

LD Less dogging

Less dogging is available on all 22 Series panic exit devices. **To order**, use prefix LD. Example LD22EO

PL Pullman latch

Pullman latches are always extended and are most commonly used in conjunction with electric strikes and LBR-less bottom rod applications. Not available with fire rated exit devices. Pullman latches do not deadlock and are not recommended for applications where security may be compromised. When the PL is specified the standard latches are replaced with Pullman style latches at an additional charge. See Pricebook for details.

GBK Glass bead kit

Glass bead kits are used on doors with raised glass beads. Each kit consists of 1/4" (6 mm) shim sets. GBK for surface vertical rod devices ship with 1/8" (3 mm) shims for rod guides. Shims are not required for top and bottom latches

To order, specify:

1. With device specify GBK in device description
2. To order separately, specify model 22GBK-R (rim), 22GBK-499F (rim), 22GBK-SV (vertical rod)
3. Finish, SP28 or SP313

229 Cover plate kit

Cover plate kit contains inside and outside plates for hinge stile cutouts, an inside plate for the lock stile, and necessary screws. Plates are designed to cover cutouts required by most existing exit device installations.

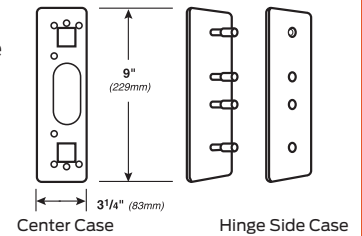

RG-27 Vertical rod and latch guard



RG-27 Series vertical rod and latch guards protect the bottom rods of exit devices from the damaging impacts of carts or gurneys passing through doors. (If bottom rods become damaged, the exit device will not function as intended and can jeopardize the ability to exit safely during an emergency.)

In addition to protecting the vertical rod, the guard provides a smooth, unobstructed surface so the door can be pushed open easily with the bumpers of a wheelchair. The latch guard portion is 10" high. The standard latch guard features a 45° ramp. The extended latch guard offers a continuous ramp in 3' or 4' widths.

All stainless steel construction in US32D finish. Latch guards can cover latches as large as 1 1/4"W x 10"H x 1 7/8" projection.

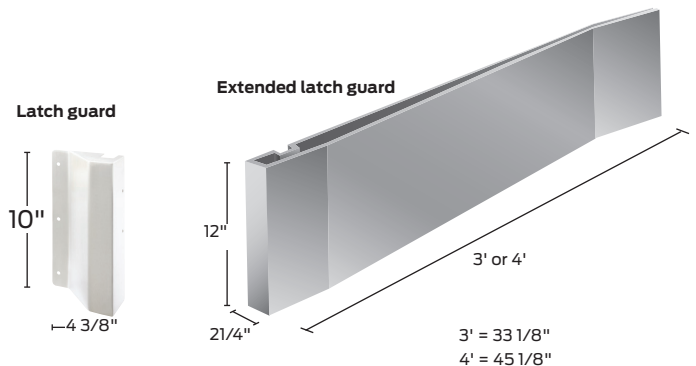

Models

- RGO** Rod guard only (Projection 1 3/16")
- RG-27** Rod and latch guard
- RG-27-3** 3' (914 mm) Rod Guard and Extended Latch Guard
- RG-27-4** 4' (1219 mm) Rod Guard and Extended Latch Guard
- LGO** Latch guard only
- LGO-3** 3' (914 mm) Extended latch guard only
- LGO-4** 4' (1219 mm) Extended latch guard only

Note: Not for use on wood fire doors, except with SLM (special laminate material) blocking.

To order, specify:

1. Model number.
2. Handing (except on RGO).
3. Door material if other than Hollow Metal.
4. Optional sex bolt mounting available.

22 Device options & accessories

Cylinders

Cylinders are not furnished with device or trim and must be specified when ordering. Refer to trim pages for cylinder type.



Mortise — 3215 (Schlage 20-001, B502-191 cam)

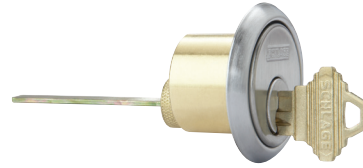
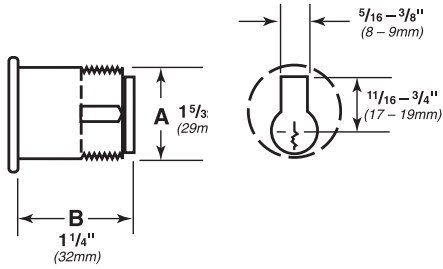

Rim — 3216 (Schlage 20-022 cam)

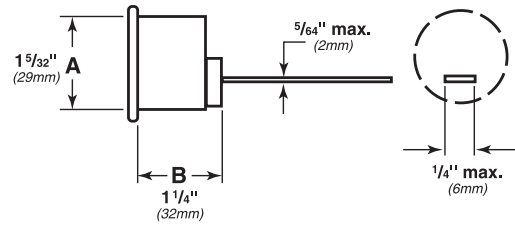

UL Listings, grade, type, function options & dimensions

UL Listed — Fire exit hardware label/opening size

Exit device	Door material	Single door		Double door					
				With mullion		Same direction**		Double egress	
22-F	HM	3 Hour	4' x 8'	3 Hour	8' x 8'	—	—	—	—
22-F	WD	90 Minute	4' x 8'	90 Minute	8' x 8'	—	—	—	—
2227-F	HM	—	—	—	—	90 Minute*	8' x 10'	3 Hour	8' x 10'
2227-F	WD	—	—	—	—	20 Minute*	8' x 10'	90 Minute*	8' x 9'
2227-F	WD	—	—	—	—	90 Minute*	8' x 9'	—	—
2227-F-LBR	HM	—	—	—	—	90 Minute*	8' x 10'	3 Hour	8' x 10'
2227-F-LBR	WD	—	—	—	—	20 Minute*	8' x 10'	90 Minute*	8' x 9'
2227-F-LBR	WD	—	—	—	—	90 Minute*	8' x 9'	—	—

ANSI Function, grade & type

*UL listing for wood doors may be for a specific door manufacturer. Consult wood door manufacturers for current UL listings.
 **Currently, no door manufacturers offer a listing over 90 minutes with doors swinging same direction.

Function	Grade 1 type 1	Grade 1 type 2
01	22EO & 22EOF	2227EO & 2227EO-F
02	22DT	2227DT
03	22NL & 22NL-F	2227NL & 2227NL-F
05	22TP & 22TP-F	2227TP & 2227TP-F
08	22K & 22K-F	2227K & 2227K-F
08	22L & 22L-F	2227L & 2227L-F

Door handing

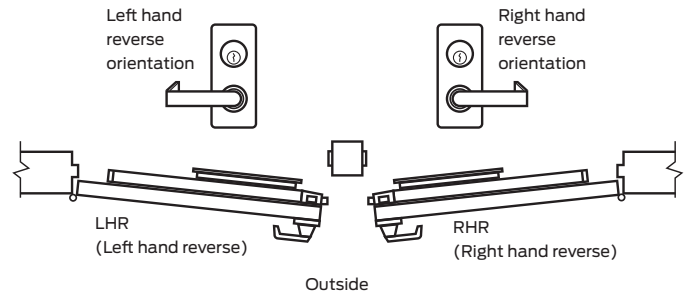

Dimensions

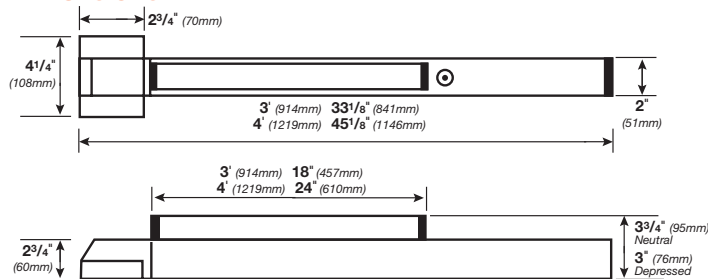

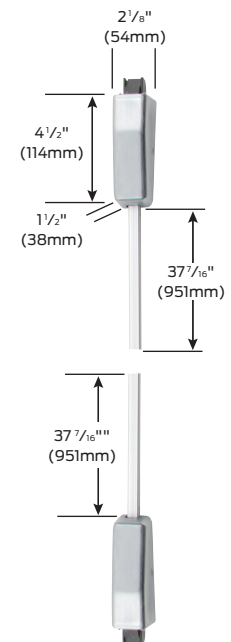

Vertical rod dimensions

Vertical rods are 1/2" (13 mm) square tubing



Finishes

Finishes*

	Color	US Number	BHMA Number
	Sprayed aluminum	SP28	689
	Sprayed dark bronze	SP313	695

* Note: Durable powder coated finishes available at specific special request. PLEASE CONTACT FACTORY.

About Allegion

Allegion (NYSE: ALLE) is a global pioneer in safety and security, with leading brands like CISA®, Interflex®, LCN®, Schlage®, SimonsVoss® and Von Duprin®. Focusing on security around the door and adjacent areas, Allegion produces a range of solutions for homes, businesses, schools and other institutions. Allegion is a \$2 billion company, with products sold in almost 130 countries.

For more, visit www.allegion.com

KRYPTONITE ■ LCN ■  ■ STEELCRAFT ■ VON DUPRIN