

# MULTIFAMILY



EXTERIOR SYSTEMS | INTERIOR SYSTEMS | MULTI-FAMILY | COMMERCIAL | HARDWARE





APARTMENTS | CONDOMINIUMS  
HOTELS | ASSISTED LIVING HOMES



# MULTI-FAMILY / RESIDENTIAL

## SUITE ENTRY DOOR SYSTEMS

- CHOOSE YOUR DOOR ..... 4-5
  - 20M Fire Rated Moulded Panel Doors ..... 4
  - 20M Fire Rated Fiberglass Doors ..... 5
  
- CHOOSE YOUR FRAME ..... 6-11
  - Wood and Composite Jamb ..... 7
  - Hollow Metal Expandable Reversible/Non-Reversible ..... 8-9
  - Metal Drywall Frames ..... 10
  - Hollow Metal Welded ..... 11
  
- CHOOSE YOUR HARDWARE ..... 12-15
  - Schlage Control™ Smart Locks ..... 12-13
  - Schlage Levers & Deadbolts ..... 14
  - Suite Entry Hardware Options ..... 15

## INTERIOR DOORS

- CHOOSE YOUR DOOR ..... 16-17
  - Non-Rated 1-3/8" Masonite Interior Doors ..... 17
  
- CHOOSE YOUR FRAME ..... 18
  - MDF Flat Jamb vs Rabbetted Jamb and  
Hollow Metal Drywall Frames ..... 18
  
- INTERIOR OPTIONS ..... 19-28
  - Interior Finishes ..... 19
  - Interior Hardware - Schlage, Dexter & Taymor ..... 20-21
  - Pocket Door Hardware ..... 22-23
  - Sliding Door Hardware ..... 24-25
  - Bypass Door Hardware ..... 26-27
  - Barn Track Hardware ..... 28
  - Barn Track Accessories ..... 29-30
  - Barn Door Kits ..... 31
  - Home Decor ..... 32

## COMMON AREAS

- Hollow Metal Doors, Welded Special Purpose  
Frames, Locksets & Hardware ..... 33-34

## BUILDING SPECIALTIES

- Washroom Accessories ..... 35
- Storage Lockers and Access Hatches ..... 36
- Hadrian Lockers and Toilet Partitions ..... 37
- Mailboxes and Garbage Chutes ..... 38
- Balcony and Storage Doors ..... 39

*Top: 20M Carrara Moulded Panel Door with Schlage Control Deadbolt with Greenwich Trim and Broadway Lever in Satin Nickel*  
*Bottom: Hollow Metal Doors and Frame with Clear Glass and Commercial Pull*

# 20M FIRE RATED DOORS

## Moulded Panel Doors



The Masonite Collection of doors feature a smooth primed product ready for painting. Composite material provides a highly durable product at great value and a timeless look for years to come.

### Stocking Size Specifications

Nominal size	Actual Size	Door Thickness	Core	Bevel
2/8 x 6/8	31-3/4" x 79-1/8"	1-3/4"	Particle Core	2 Edge
3/0 x 6/8	35-3/4" x 79-1/8"	1-3/4"	Particle Core	2 Edge

Special order: Widths 2/0 to 3/6 and 7/0 (83-1/8") in height.

### Specifications

#### Paint

Paintable moulded wood; smooth primed surface.  
Factory painting and polybagging upon request

#### Fire Rating

A 20 minute rated door meets requirements for a 60 minute wall rating

**DOORS:** Fire rated to 20 minutes with a label attached.

**DOORS:** Fire rated to 45 minutes with a label attached. (Primed Hardboard only)



#### Door Preparation / Templates

Framed prepped for 3 4-1/2" x 4" square leaf hinges. Frame prepped for ASA strike.

#### Handing

Hand (swing) of door from key opening side:



#### Hardware Consideration

Door stile widths are designed to accommodate standard roses on residential lever locks. Commercial and architectural hardware may require special consideration.

Recommended lock placement is 44" from top of door to center line of panel



Carrara  
CARR

6 Panel  
COL

Recommended lock placement is 39-9/16" from top of door



Lincoln Park  
LINC

Riverside  
RIV

Berkley  
BER

Primed Hardboard  
HP

# Suite Entry

## Fiberglass Doors

 FIRE-RATED FIBERGLASS

Fiberglass doors feature a full length steel reinforced wood lock block offering exceptional security while allowing for a range of hardware mounting options. Fiberglass skins are resistant to dents, dings, splintering or corrosion and rigid internal structure provides sound dampening qualities. Available in either pre-pigmented maintenance-free smooth white or woodgrain textured to provide the warmth and natural beauty of wood, when stained.

### Stocking Size Specifications

Nominal size:	Actual Size:	Door Thickness:	Core	Bevel
2/8 x 6/8	31-3/4" x 79"	1-3/4"	Polyurethane	N/A
3/0 x 6/8	35-3/4" x 79"	1-3/4"	Polyurethane	N/A

Note: Fire code regulation require a maximum of 6mm clearance from door to finished floor. A sill may be required.

### Specifications

#### Paint or Stain

Smooth white pre-pigmented fiberglass doors have a warm white finish to match a composite frame or can be painted to match the decor of your home. Woodgrain textured fiberglass doors have a realistic rich appearance requiring paint or stain. Factory painting or staining\* upon request.

#### Fire Rating

A 20 minute rated door meets requirements for a 60 minute wall rating  
**DOORS:** Fire rated to 20 minutes with label attached.  
**DOORS:** N/A in 45 minutes



#### Door Preparation / Templates

Doors prepped at 44" o/c or 39-9/16" o/c (as noted) with 4-1/2" x 4" square leaf hinges.

#### Handing

Hand (swing) of door from key opening side:



#### Hardware Consideration

Door stile widths are designed to accommodate standard roses on residential lever locks. Commercial and architectural hardware may require special consideration. Blocking for exit device and closer included.

\*Printed staining swatch colours may vary slightly from actual product. If you are concerned about exact colour match, we recommend you first request a product sample for accuracy.

#### Staining Options\*



Black Walnut



Coffee Bean



Walnut



Chestnut



Red Mahogany

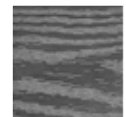

Grey

Recommended lock placement is 44" from top of door to center line of panel

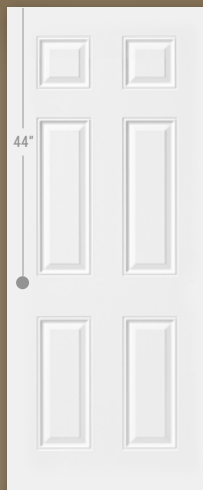

SG62  
6 panel



WG68  
6 panel

Recommended lock placement is 39-9/16" from top of door



SG25  
2 panel, 3/4 lite



WG25  
2 panel, 3/4 lite



# *Suite Entry* MULTI-FAMILY FIRE-RATED



## 20M FIRE RATED FRAMES

Complement your new door with a frame designed from primed finger-jointed pine or composite (smooth white or textured woodgrain). Available in 20 minute fire rating only.

*For 45-90 minute fire ratings, see our selection of galvanized hollow metal frames.*

**Consider a Prehung System for Ease of Install.**

### 20M Fire Rated Finger-Joint Pine Frame (Primed)

#### With Kerf Weatherstripping

Primed, kiln-dried finger-jointed pine jambs provide beauty and strength with a Warnock Hersey certified 20 minute fire rating. Suitable for interior or exterior use. Weatherstrip available in black or white.

**Sizes:** To partner with the door

**Jamb depth:** Up to 8-7/8"

#### Without Kerf Weatherstripping

Primed, kiln-dried finger-jointed pine jambs comply with a Warnock Hersey 20 minute fire rating. Optional smoke seal can be used with this jamb for extra sound and smoke protection.

**Sizes:** To partner with the door

**Jamb depth:** Up to 7-13/16"



Frame with kerf weatherstripping

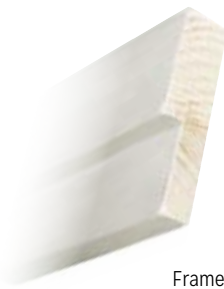

Frame without kerf weatherstripping

### 20 Minute Fire Rated Composite Frame



Nan Ya's unique composite jamb offers built-in advantages unmatched in the door industry. Maintenance-free composite provides a tough exterior finish—resistant to dents, dings and scratches—and solid composite structure offers superior screw holding power, which means less work for you and a longer life for your entry unit.

Composite frames are available in either pre-pigmented smooth white or woodgrain textured finishes. Though finishing is not required for smooth white frames, they will accept an array of paint colours to match the design and finish of the door. Woodgrain textured frames have a realistic rich appearance, requiring paint or stain to achieve the warmth and beauty of natural wood. Factory finishing available.

**Sizes:** To partner with the door

**Standard jamb depth:** 4-9/16", 6-9/16", 8-9/16"



Composite frame with kerf weatherstripping, available in black or white

# UP TO 90 MINUTE FIRE RATED FRAMES

## Expandable EF-EFK Technical Data

---

### Finishing

Galvanneal steel is matte grey and ready for the finish paint—primer is not required.

### Expandable Slide Bracket

These brackets are manufactured from 16 gauge galvanneal steel which are spot welded to the frame material. Three sliders are used on frame jambs and two sliders are used on frame heads to allow for smooth operation.

### Reinforcements

Reinforcements are welded to the frame for three hinges and strike placement. The strike jamb leg is prepped for a 4-7/8" ANSI strike. Closer reinforcement is 12 gauge and welded to the header.

### How to Install an Expandable Frame

Frame jambs have corner tabs spot welded at the seam which interlock with slots on the frame head. This product is then bent over to pull the corners at the head and jamb legs, creating a tight joint.

The frame faces are dimpled in three locations on the jambs and two locations on the heads, allowing for screw fastening of the frame to the wall.

Bondo screw holes after installation, before painting.

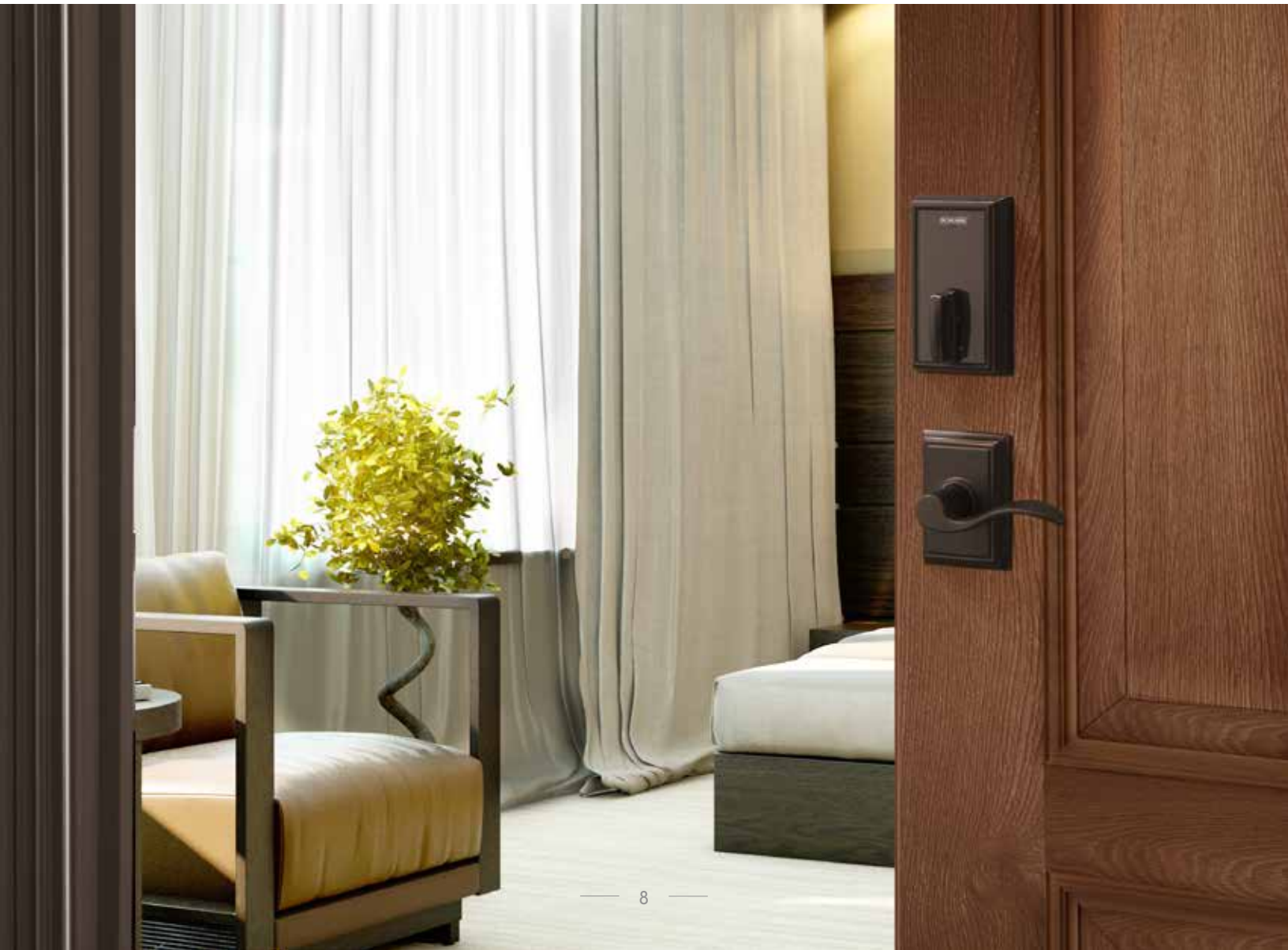



# Suite Entry



FIRE-RATED FRAMES

## Expandable EF-K Frame Series (Reversible Handing)

### Reversible Square Corner - 18 ga. Steel

The Daybar Expandable EF-K Series frames are an ideal solution for commercial building applications and retrofit work on existing buildings, especially when existing wall types are unknown or vary throughout the project. For new construction, the reversible handing and ease of installation make this a frame of choice for installers.

Nominal Door Size	Actual Door Size	Rough Opening	Swing
2/8 x 6/8	31-3/4" x 79-1/8"	33-3/4" x 81"	Reversible
3/0 x 6/8	35-3/4" x 79-1/8"	37-3/4" x 81"	Reversible
2/8 x 7/0	31-3/4" x 83-1/8"	33-3/4" x 85"	Handed
3/0 x 7/0	35-3/4" x 83-1/8"	37-3/4" x 85"	Handed

**Standard Series** Expandable from 4-1/2" to 7-7/8"

**Fire Rating** 20 to 90 minute 

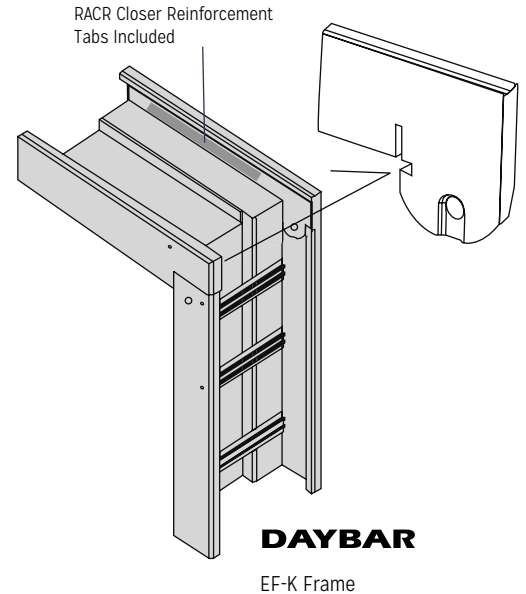

## Expandable EF Frame Series (Non-Reversible)

### EF Mitred Corner - 16 ga. Steel

Daybar's EF Series frames are designed to accommodate the broadest range of wall construction with a single adjustable product. EF Series features a two piece frame component, held together with a bracket system and spot welded to the frame material, allowing the jamb depth to be reduced or increased based on site conditions.

Nominal size	Actual Size	Rough Opening	Swing
2/8 x 6/8	31-3/4" x 79-1/8"	33-3/4" x 81"	Handed
3/0 x 6/8	35-3/4" x 79-1/8"	37-3/4" x 81"	Handed
2/8 x 7/0	31-3/4" x 83-1/8"	33-3/4" x 85"	Handed
3/0 x 7/0	35-3/4" x 83-1/8"	37-3/4" x 85"	Handed

**EF-1 (Special Order Only)** Expandable from 3-1/2" to 5-1/4" wall thickness

**EF-2** Expandable from 5-3/8" to 8-11/16" wall thickness

**EF-3** Expandable from 8-11/16" to 12" wall thickness

**Fire Rating** 20 to 90 minute 

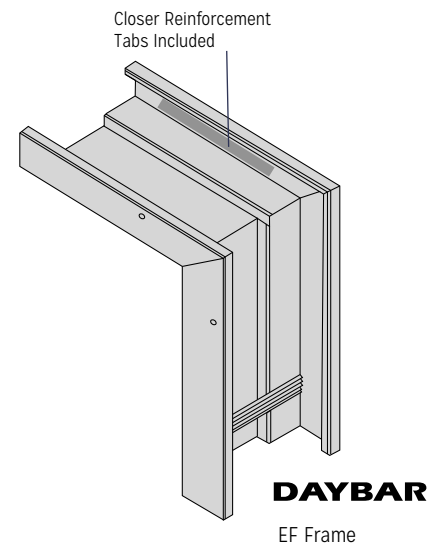

*WG25 Fiberglass Woodgrain Door Stained in Chestnut, with Schlage Control Deadbolt with Addison Trim and Accent Lever in Aged Bronze.*

## K Series Drywall Frames

# DAYBAR

**NOTE:** For 1-3/4" door thickness.

One person can install Daybar drywall frames quickly and efficiently

**Usage:** Interior – commercial or industrial.

### Installation

Drywall frames are supplied in three pieces and are installed after the framing stage. Jambs have corner tabs spot welded at the mitre, interlocking with slots on the frame head. This tab is then bent over to make a tight joint. Each jamb has a dimpled base anchor for fastening to the floor plate and tension anchor at the top.

### Reinforcements

Reinforcements are welded to the frame for three hinges and strike placement. The strike jamb leg is prepped for a 4-7/8" ANSI strike.

<b>Fire Rating</b>	20 to 90 minute 
<b>Rough Opening</b>	<b>Width</b> = Nominal door width plus 2" <b>Height</b> = Nominal door height plus 1-1/4"
<b>Finishing</b>	Galvanneal steel is matte grey and ready for the finish paint–primer is not required.

Model	Jamb Depth	Throat*
350K	4-1/2" (114mm)	3-1/2" (89mm) <i>(Special order)</i>
462K	5-5/8" (143mm)	4-5/8" (118mm)
487K	5-7/8" (149mm)	4-7/8" (124mm)
525K	6-1/4" (159mm)	5-1/4" (133mm) <i>(Special order)</i>
675K	7-3/4" (197mm)	6-3/4" (172mm) <i>(Special order)</i>
725K	8-1/4" (210mm)	7-1/4" (184mm) <i>(Special order)</i>

\*Throat size should match wall thickness. It is common for throat sizes to exceed wall thickness by 1/8". Caulking is used to fill any additional spacing.



Lincoln Park Door with Schlage Control Deadbolt with Greenwich Trim and Broadway Lever in Aged Bronze.

## Hollow Metal Welded Frames

**Usage:** Interior or exterior – residential, commercial or industrial.

### Single opening

16 gauge galvaneal steel is fully welded across the visible side of both faces. Exposed welds are ground, finished and prime painted. Each frame will have two spreader bars tack welded in place. The spreader bars are used to square the frame and keep it stable during shipping to site.

<b>Fire Rating</b>	up to 180 minute
<b>Rough Opening</b>	<b>Width</b> = Nominal door width plus 4-1/4" <b>Height</b> = Nominal door height plus 2-1/4"
<b>Finishing</b>	Galvaneal steel is matte grey and ready for the finish paint—primer is not required.



Hollow Metal Door with Closer and Commercial Hardware

## DAYBAR

### AS Series Hinge & Strike Preparation

#### AS Series Frame Sizes

	Model	Jamb Depth	Throat*
STANDARD	AS 4-3/4"	4-3/4" (121mm)	3-3/4" (95mm)
	AS 5-3/4"	5-3/4" (146mm)	4-7/8" (121mm)
	AS 6-3/4"	6-3/4" (172mm)	5-3/4" (146mm)
	AS 8-3/4"	8-3/4" (222mm)	7-3/4" (196mm)

\*Throat size should match wall thickness. It is common for throat sizes to exceed wall thickness by 1/8". Caulking is used to fill any additional spacing.

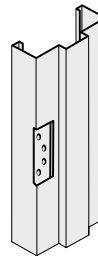

4-1/2" (114) hinge preparation - 10GA. (3.4) reinforced with dust box.

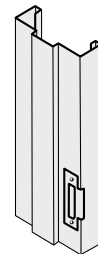

4-7/8" (124) strike preparation [ansi A115.1] - 14GA. (2.0) reinforced dust box.

### Wall Anchor styles

Fully welded frames are designed to be installed during wall construction and come with welded base angles on each jamb for securing to the floor. Each frame is supplied with masonry, wood stud anchors or steel stud anchors as required.

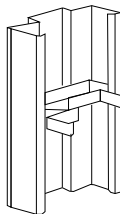

Adjustable stud anchor

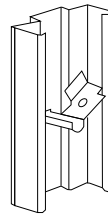

Existing masonry anchor

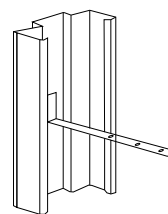

Masonry strap anchor

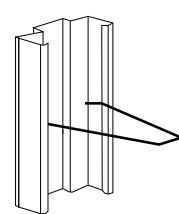

Masonry wire anchor





## A NEW ERA FOR MULTI-FAMILY BEGINS

Introducing the next generation of electronic access for the world of multi-family—Schlage Control™ Smart Locks. More than a solution for streamlining operations and boosting a property's appeal, it's a new era of answers for every door you manage.

Schlage Control Smart Deadbolts and Schlage Control Smart Interconnected Locks eliminate dealing with traditional keys, while giving residents convenient smart card and phone credentials. Open architecture design delivers the ability to manage both residence and common area doors on the same system.

Schlage Control comes standard with ENGAGE™ technology, which provides connectivity and lock management for facilities staff through the ENGAGE app. This technology also allows residents to gain access using sophisticated smart technology. From a smart phone, tablet or computer, you can quickly add users, view a history of access, get data, receive alerts and more.

# Suite Entry

 FIRE-RATED HARDWARE

## Schlage Control™ Smart Locks

Schlage Control™ Smart Deadbolt locks are ideal for multi-family communities, senior living communities and student housing.



**BE467F ADD 716**  
Addison trim with Accent  
lever in Aged Bronze  
*Lever sold separately*



**BE467F GRW 619**  
Greenwich trim with Broadway  
lever in Satin Nickel  
*Lever sold separately*



### Benefits

- **Increases efficiency of property operations**
- **Easy installation**
  - No wiring or modifications to the door frame necessary
- **No cylinder design eliminates traditional keys**
  - 100% pick and bump proof
  - No tour functionality (manage locks without visiting them)
  - Set up and later access wirelessly from various mobile devices or computers

### Finishes Available



**619**  
Satin Nickel



**626**  
Satin Chrome



**625**  
Bright Chrome



**716**  
Aged Bronze

### Specifications

<b>Fire Rating</b>	90 minute UL listed
<b>Bore</b>	2-1/8"
<b>Stile Width</b>	4-1/2" stile for 2-3/8" backset 5" stile for 2-3/4" backset
<b>ADA Compliant</b>	Yes
<b>Battery</b>	4-AA batteries included (9 volt can be used to jump start with assigned credentials)
<b>Backset</b>	Adjustable 2-3/8" to 2-3/4"
<b>Latch</b>	1" x 2-1/4" radius or square; 1" edge bore required
<b>Strike</b>	1-1/8" x 2-3/4" round corner, no box, latch strike



## Schlage Keyed Levers and Deadbolt



20 minute doors require a 20 minute fire rated latch.

**Must be specified to contain UL rated latch to comply with fire rating requirements.**

- Designed to resist a variety of security attacks, including kick-ins, credit card, picking, and bumping
- Installation is a snap with posts that guide the screw into the proper location
- Fits all standard door preps, with lever designs reversible in-field
- Master keying and construction keying available upon request



**Latitude**  
619, 622, 625, 626



**Broadway**  
619, 622, 625, 626, 716



**Latitude/Collins**  
608, 619, 626



**Merano**  
619, 622, 625, 626, 716



**Accent**  
619, 620, 622, 625, 716



3-hour UL listed  
fire cup/latch  
available



**B60F**  
619, 622, 625,  
626, 716

### Non-Rated Sense Touchscreen



**BE479V CEN 619**  
Satin Nickel

### Finishes Available Levers & Deadbolts



**608**  
Satin Brass



**619**  
Satin Nickel



**620**  
Antique Pewter



**622**  
Matte Black



**625**  
Bright Chrome



**716**  
Aged Bronze



**626**  
Satin Chrome

## Falcon Knob, Levers & Deadbolt



a division of Allegion  
Hardware

For use in public entry areas.

**Contains UL rated latch to comply with 20, 45 and 90 minute fire rating requirements.**

- Reliable and proven Grade 2 construction
- Heavy duty springs for better lever return and to prevent sagging
- Non-handed for easy assembly
- Schlage C masterkey available



**Hana Knob**  
626



**Dane Lever**  
626



**Quantum Lever**  
626



**241P6F**  
626



# SUITE ENTRY HARDWARE OPTIONS

Fire rating of 20 minutes requires a self closing mechanism for all suite entry openings. Select from either a door closer or self closing hinges.

## SC90 Series Door Closers

Falcon Series closers ensure smooth, reliable operation, while meeting ADA accessibility requirements. Designed for light to moderate duty, interior/exterior applications and preset for easy installation.

### Specifications

- Grade 3, single piece cast aluminum body
- Closer mounts hinge side, top jamb or parallel arm
- Non-handed for left or right hand swinging doors
- Separate adjustable general speed or latch speed
- Universal screw pack
- 10 year warranty
- SC93 supports door weight of 90-145 LBS



## Self Closing Hinges

- Satin Chrome finish
- Quality wood screws and undercut machine screws are included

### Installation

- 2 required. Recommended installation—middle and lower hinge placement. Eliminates the weight bearing strain on the top hinge

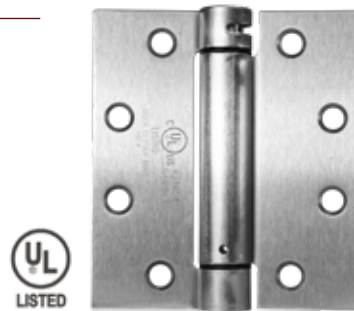

**Hollow Metal Frames:** 4-1/2" x 4" square leaf, ball bearing

**Wood Frames:** 4-1/2" x 4" square leaf, ball bearing

## Door Viewer

Cal Royal (ULDV200 Viewer)

### Specifications

- For doors 1-3/8" to 2" thick
- Finishes: 615, 626, 625, 10B
- 200 degree glass lens
- Bore: 9/16"
- UL Listed for 90 Minutes / ANSI, BHMA



## Smoke Seal

S88BL Pemko

### Specifications

- Silicon polymer, self adhesive, black
- Effective temperature range of -58° to +450° Fahrenheit (-50° to +232° Celcius)
- Not affected by mildew, fungus or ultra-violet light



## Automatic Door Bottom

Pemko 4301 PKL

### Specifications

- Low closing force
- End plates provided for all mounting applications.
- Slotted holes for adjustment



Surface Applied

Pemko 411 APKL

### Specifications

- Smoother action positive seal mechanism
- Available in any size ranging from 18" to 48"



Mortised Automatic

## Door Numbers

### Specifications

- Made of solid brass
- 4" high
- Screws included
- Available in Bright Brass, Satin Nickel and Aged Bronze



# *Interior Doors* MULTI-FAMILY



*Painted Logan Shaker Door with  
Schlage Latitude Lever in Satin Chrome*

# Interior Doors

NON-RATED 1-3/8" DOORS

## NON-RATED 1-3/8" INTERIOR DOORS

### Masonite Interior Door Collection



The Masonite Collection of doors feature a smooth primed surface ready for painting. These doors feature a composite material which provides a highly durable product at great value and a timeless look for years to come.

**NOTE:** Nominal and actual sizes are the same

<b>Height</b>	6/8
<b>Widths</b>	1/6, 2/0, 2/4, 2/6, 2/8, 2/10, 3/0
<b>Thickness</b>	1-3/8" (1-3/4" Hollow core, solid core - special order)
<b>Core</b>	<p><b>Hollow Core</b></p> <ul style="list-style-type: none"> <li>• Perfect solution for budget-minded customers</li> <li>• 1-3/8" thickness available, primed white and ready to paint.</li> <li>• Contains pre-consumer recycled content, resource efficient materials and a honeycomb core.</li> </ul> <p><b>Safe 'n Sound Solid Core (Special Order)</b></p> <ul style="list-style-type: none"> <li>• For reduced sound transmission; ideal for bathrooms and bedrooms where privacy and safety are a concern.</li> <li>• Manufactured with DorCor™, a low density fiberboard made from wheat straw (annually renewable, agricultural, wheat by-product).</li> </ul>
<b>Paint</b>	Paintable moulded wood; smooth primed surface
<b>Door Preparation</b>	Doors prepped at 44" or 40" with 3-1/2" ball bearing 1/4" radius leaf (handed) or 5/8" radius / square leaf for (reversible).
<b>Handing</b>	<p>Hand (swing) of door from key opening side</p>
<b>Warranty</b>	1 year limited warranty



**hollow core**



**safe'n sound**  
SOLID CORE MOULDED PANEL DOORS

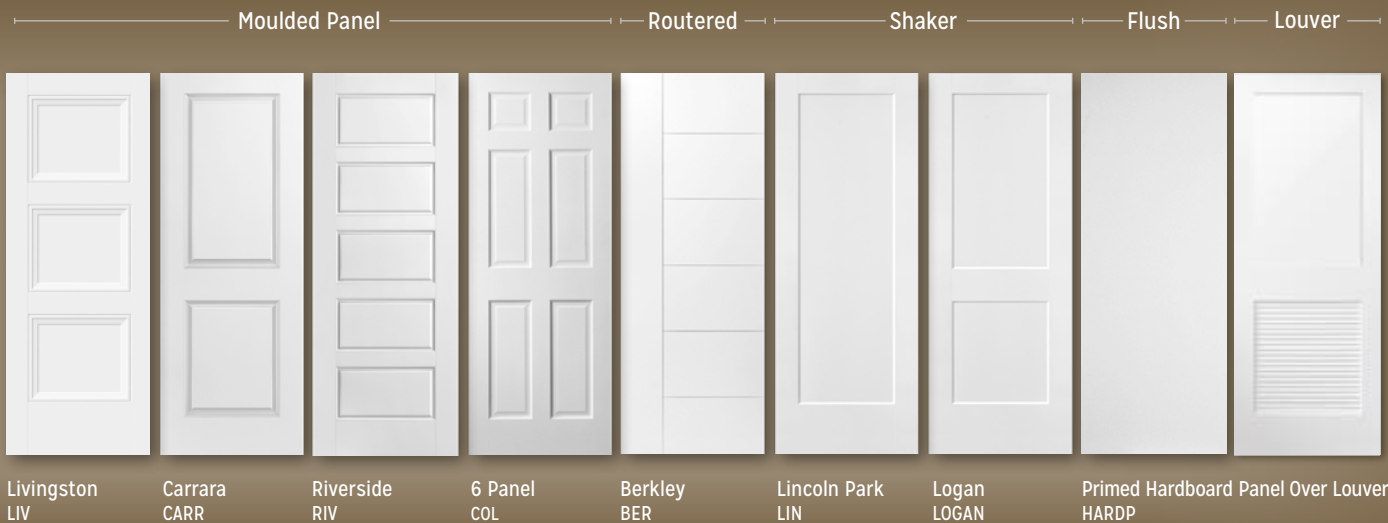



## NON-RATED INTERIOR FRAMES FOR 1-3/8" DOORS

### MDF 4-9/16" Flat Jambs c/w 3422 Bullnose Stop

- Jamb packs ship complete with jamb, stop and a set of 3 3-1/2" hinges in the finish of your choice.
- Available in handed with ball bearing or reversible plain bearing specification.

#### Rough Opening

**Width** = Door width plus 2" | **Height** = Door height plus 1-1/4"



MDF Flat Jambs and Stop

### Finger-joint Pine 1-3/8" Rabbeted Jamb

- Jamb pack ships complete with jamb and a set of 3 3-1/2" ball bearing hinges in the finish of your choice.
- Available in right handing or left handing only.
- Consider pre-hung unit for ease of install.

#### Rough Opening

**Width** = Door Width plus 2" | **Height** = Door Height plus 1-1/4"



Finger-joint Rabbeted Jamb

### S Series Drywall Knock Down Frames - Hollow Metal

**NOTE:** S Series frames are for use with 1 3/8" door thickness. Available on project based requests.

- Interior multi-family, hotel use (bathrooms, closets)
- Sold with 3-1/2" hinges square
- Available with drilling height of 40" OC or 44" OC from top of door.

#### Specifications

- 18 gauge A40 Galvanneal Steel (passivated for easy paint application)

#### Rough Opening

**Width** = Door Width plus 2" | **Height** = Door Height plus 1-1/4"

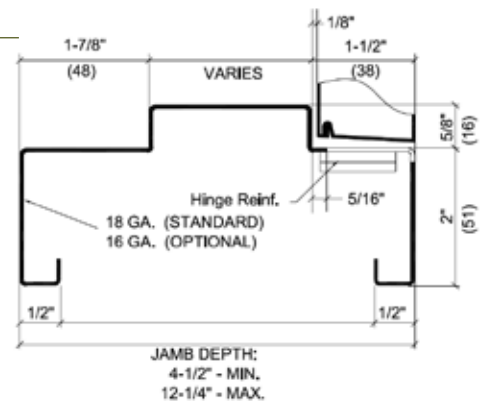

**DAYBAR**

## Residential Door Hinges



Reversible Hinge



1/4" Radius Ball Bearing Hinge

#### Finishes Available



**C-2G**  
Zinc  
Plated



**C-4**  
Brushed  
Brass



**C-10B**  
Oil Rubbed  
Bronze



**C-15**  
Satin  
Nickel



**C-15A/  
C-17A**  
Antique Nickel



**C-26D**  
Brushed  
Chrome



**C-32D**  
Stainless  
Steel



**C-ID**  
Matte  
Black



**Rubbermaid**®

**Rubbermaid Wire Shelving**

Rubbermaid carries the standard for high quality steel epoxy coated wire shelving. Durable and reliable, it has become the norm in most new homes. White or Satin Nickel finish.

# INTERIOR FINISHINGS



**ALEXANDRIA**  
Moulding

From the clean sophisticated lines of painted trim to the timeless quality of solid wood, Alexandria Moulding has the product to suit your project needs.



*Painted Carrara Moulded Panel Door with Schlage Solstice Lever in Satin Chrome*

## Schlage Interior Locksets



- Available in dummy, passage and privacy function
- Designed to resist a variety of security attacks, including kick-ins, credit card, picking, and bumping
- Installation is a snap with posts that guide the screw into the proper location
- Fits all standard door preps, with lever designs reversible in-field
- Master keying and construction keying available upon request



**Plymouth/Greenwich**  
619, 620, 622, 625, 626, 716



**Broadway**  
619, 622, 625, 626, 716



**Latitude/Collins**  
608, 619, 626



**Latitude**  
619, 622, 625, 626



**Accent**  
619, 620, 622, 625, 716



*3-hour UL listed  
fire cup/latch  
available*

## Finishes Available



**608**  
Satin Brass



**619**  
Satin Nickel



**625**  
Bright Chrome



**620**  
Antique Pewter



**626**  
Satin Chrome



**622**  
Matte Black



**716**  
Aged Bronze



# Interior Doors

 FIRE-RATED HARDWARE

## Dexter Deadbolt & Levers



**Must be specified to contain UL rated latch to comply with fire rating requirements.**

- Strongest locks in the opening price point category
- Dexter designs corresponds with Schlage's most popular designs
- May be keyed to the Schlage C keyway
- Dual or triple option latches come standard
- Fits standard door preps
- Easy to install



**Solstice/Collins**  
619, 625, 626, 716



**Seville**  
619, 625, 716



**Stratus**  
619, 625, 716



**Corona**  
630



**Broadway Collins**  
619



**Marin**  
619, 630

### Finishes Available

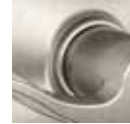

**619**  
Satin Nickel



**625**  
Bright Chrome



**620**  
Antique Pewter



**626**  
Satin Chrome



**630**  
Satin Stainless Steel



**716**  
Aged Bronze

## Taymor 4 Piece Bathroom Sets



- Towel Bar, Paper Holder, Towel Ring, Robe Hook
- Concealed surface or screw mount
- Limited lifetime warranty



**Ultra 4pc Set**  
15, 26



**Spellbound 4pc Set**  
26



**Naples 4pc Set**  
15, 26



### Finishes Available



**15**  
Satin Nickel



**26**  
Polished Chrome



*Glazed French Door with Frosted Glass in Pocket Opening*

## POCKET DOOR HARDWARE



### Johnson Pocket 1500 \$



Suitable for 1-3/8" doors up to 125 lbs each. 1-3/4" requires adapter kit.

This series is designed to carry heavy standard size doors in standard 2 x 4 timber or steel framed stud walls. It is versatile and can be adapted for use in non standard wall thicknesses, block masonry walls, and can be cut down to accept any smaller size door.



<b>Stocking Size</b>	Max 36" width x 6/8, 8/0 height; 4-1/2", 6-1/2" wall thickness
<b>Application</b>	Interior, Residential
<b>Capacity</b>	125 lbs (57 kg) each
<b>Door Thickness</b>	1-3/8", 1-3/4 requires adapter kit
<b>Add-Ons</b>	<b>Johnson 1060 Soft Close Kit</b>

Make your sliding doors soft close quietly and securely.

**Features**

- For doors up to 200 lbs (91 kg).
- Use with new or existing Johnson Hardware sliding and pocket door hardware
- Holds door securely in place.
- Prevents pinched fingers between door and jamb.



Johnson 1060 Soft Close Kit

**Johnson 1125 Ball Bearing Wheel Kit**

**Features**

- For doors up to 200 lbs (91 kg).
- 3/4" wheel diameter
- Height adjustable
- Commercial Grade



Johnson 1125 Ball Bearing Wheel Kit

### Crowder Type C Pocket \$\$



Suitable for doors to 150 lbs.

This series provides easier and quicker installation than a traditional pocket door frame built on site thanks to its quick release hanger.

- Can be installed in single door or double bi-parting door applications
- Use with CP-801 Extruded Aluminum Header Track, 6061-T5 Alloy.

<b>Size</b>	Suitable for 2/0 to 3/0 wide and 6/8 to 7/0 doors
<b>Application</b>	Interior, Residential, Commercial
<b>Capacity</b>	150 lbs each
<b>Door Thickness</b>	For 1-3/8" to 1-3/4" wood doors
<b>Add-Ons</b>	<b>CC-493 Easy Connect Catch n' Close Hanger</b>

- Provides easier and quicker installation than a traditional pocket door frame built on site
- Catch'N'Close system prevents bouncing and slamming of the sliding doors and can be installed on both the opening and closing ends of the door

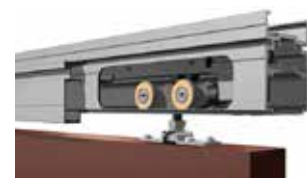

CC-493 Easy Connect Catch n' Close Hanger



*Painted Berkley Door with Johnson Sliding Track*



## SLIDING DOOR HARDWARE

### Johnson 2610SC Sliding Track & Hardware \$



The 2610SC is a versatile and easy to install soft closing wall mounted sliding door hardware set ideally suited where the installation of a Pocket Door is not structurally possible or cost effective, including closets, storage rooms or anywhere space is limited. It is for interior use only and not suited for external applications.

<b>Size</b>	48" max width
<b>Application</b>	Interior, Residential
<b>Capacity</b>	1-3/8" or 1-3/4" doors up to 200 lbs (91kg) each
<b>Finishes</b>	Mill grade aluminum or anodized bronze



### KrisTrack KT47 Wall Mount Sliding Door Track \$\$ **KrisTrack®**

From closet doors to custom room dividing door applications, KrisTrack manufacturers a complete range of sliding door hardware that is sure to meet your specific needs.

<b>Size</b>	Width and height of door may vary, provided weight does not exceed maximum hanger weight listed.
<b>Application</b>	Interior, Residential & Commercial
<b>Capacity</b>	1-3/8" or 1-3/4" doors
<b>Finishes</b>	Extruded aluminum, mill finish
<b>Add-Ons</b>	<b>KT38 Hanger</b> (for 1 door): Max door weight 132lbs (60kg) <b>KT40 Hanger</b> (for 1 door): Max door weight 220lbs (100kg)

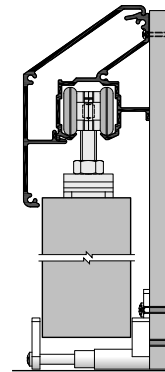

KT38 Hanger



KT40 Hanger

### KN Crowder C-108 Barn Style Track \$\$



*For Single & Bi-Parting Wall Mounted Doors (Medium to Heavy Duty)*

This track system is suitable for all types of heavy sliding doors. It features four precision, heavy duty ball bearing, nylon tire wheels per hanger. Locknuts hold the vertical adjustment. Crowder C-108 Side-Mount Track is an all-in-one track solution that eliminates the need for additional hardware or millwork, for wall mount sliding door conditions.

<b>Size</b>	Kits available for 24" [610mm] to 72" [1829mm] wide doors.
<b>Application</b>	Interior, Residential, Commercial
<b>Capacity</b>	1-3/8" or 1-3/4" doors up to 175lbs (80kg) each
<b>Finishes</b>	Mill finish, clear or bronze anodized
<b>Add-Ons</b>	<b>C-110 Snap-on Fascia (shown)</b> <b>CC-993 Catch n' Close</b> <ul style="list-style-type: none"> <li>· Load Capacity 200 lbs. (two Hangers)</li> </ul>





Painted Logan Moulded Panel Door  
with Johnson Bypass Track

## BYPASS DOOR HARDWARE

### BYPASS DOOR HARDWARE

### Johnson I166 Bypass Track & Hardware \$



An economical prefinished gold colored steel bypass track with convex track rails, which provide one point contact between wheel and track. One wheel (7/8" dia.) hangers with three point locking. One inch high woodtone adjustable door guide. Brass-tone steel parts.

<b>Size</b>	48", 60", 72"
<b>Application</b>	Interior, Residential
<b>Capacity</b>	1-3/8" or 1-3/4" doors up to 50 lbs (23kg) each
<b>Finishes</b>	Gold coloured steel

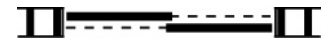

2-door bypass



3-door bypass



4-door bypass

### KrisTrack KT50 Bypass \$



From closet doors to custom room dividing door applications, KrisTrack manufacturers a complete range of sliding bypass door hardware that is sure to meet your specific needs.

<b>Size</b>	8 lengths available
<b>Application</b>	Interior, Residential & Commercial
<b>Capacity</b>	1-3/8" or 1-3/4" doors, 100-220 lbs (45-99kg) each, dependent on hanger. Max door height 84"
<b>Finishes</b>	Extruded aluminum, mill finish
<b>Optional</b>	KT5 Fascia, extruded aluminum painted white, 10 lengths

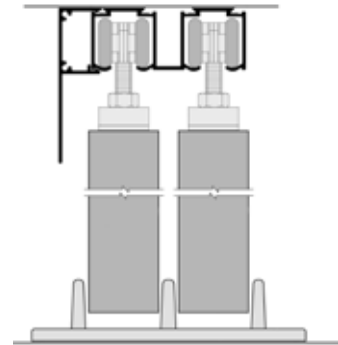

### Crowder C400 Bypass \$\$



*For Single & Bi-Parting, By-Passing, Pocket or Wall Mounted Doors.*

This series provides the ultimate in smooth sliding door track performance. Eight ball bearing, nylon tire wheels per door. Features vertical adjustment by threaded door top plate and locknut. Ideal for mirror covered and solid core doors.

- Can be mounted side by side for by-pass applications (requires 2 kits).
- Use with Extruded Aluminum C-400 Track, 6063T5 Alloy.

<b>Size</b>	Kits available for 24" [610mm] to 72" [1829mm] wide doors.
<b>Application</b>	Interior, Residential, Commercial
<b>Capacity</b>	1-3/4" doors up to 125lbs each
<b>Add-Ons</b>	<b>CCD-493-W Easy Connect Catch n' Close Hanger</b>

- Available for use on top and side mounted tracks, pocket doors, single bi-parting doors, and some barn door applications.
- Smooth and silent operation and eliminates slamming
- Can be installed on the opening and closing end of doors as heavy as 150lbs. or 18" in width. The units have been cycle tested for 50,000 cycles without fail and can be replaced without removing the track.



Mounting Applications



CCD-493-W Easy Connect Catch n' Close Hanger



# BARN TRACK HARDWARE



## Barn Track Hardware Kits

<b>Hangers</b>	Bent Strap, Straight Strap or Top of Door Strap
<b>Application</b>	1-3/8" to 1-3/4" thick door; maximum weight 250 lbs per door
<b>Track</b>	78-3/4" or 96" trimmable flat track; 1-9/16" height
<b>Opening</b>	Up to 36" wide; multiple tracks required for wider openings
<b>Finishes</b>	Matte Black or Stainless Steel
<b>Contents</b>	Hardened steel track, wall spacers, anti-jump blocks, track end stops, floor guide, wall- mounted guide, floor-mounted guide, track mounting screws, concrete bolts and anchors



Bent Strap



Straight Strap



Top of Door Strap



Matte Black



Stainless Steel



## BARN TRACK ACCESSORIES

### Handles (Sold Separately)



**Flat Handle**  
Available in Stainless Steel  
and Matte Black



**Rectangular Recessed**  
Available in Stainless Steel  
and Matte Black



**Deben Tubular**  
Available in Stainless Steel  
and Matte Black



**Barons Fleur**  
Available in  
Matte Black



**Roding Curved**  
Available in  
Matte Black



**Woodford Squared**  
Available in  
Matte Black



**Alperton Tubular**  
Available in  
Matte Black

### Adapter Kits (Sold Separately)

For double door barn track application requiring 2 track lengths.  
Adapter kit includes hex key and 4 heavy-duty matching screws



Stainless Steel



Matte Black

## BARN DOOR ACCESSORIES



Easy Latch



Tear Drop

### Privacy Latches for Barn Door Hardware Kits

Renin's Easy Latch Barn Door Lock (Left) is surface mounted without the need to remove or router the door making the installation process quick and easy. Available in Matte Black.

Renin's Tear Drop Privacy Latch (right) is mounted to the jamb and to lock, simply slide the tear drop latch towards the strike plate mounted on the door. Available in Stainless Steel and Matte Black.



### Easy Clip Soft Close Hardware Kit

Easy Clip Soft Close attachment is designed to install quickly and discreetly onto most flat track barn door hardware kits. This patent pending low profile attachment is hidden behind the barn door track and can be easily installed in minutes to any new or previously mounted barn door kit. The first attachment of its kind attaches on both ends of the track for smooth travel and effortless open and close functionality.



### Bifold Barn Door Hardware Kits

Bifold system does not require extra wall space as the entire track slides within the opening. This gives your room a major design upgrade while incorporating function and space savings

Kit includes two steel barn door hangers and 48" or 78-3/4" track, finished in matte black. Doors sold separately.

48" Track is compatible with (\*2) 12", (\*2) 15", and (\*2) 18" wide door slabs.

78-3/4" Track is compatible with (\*4) 12", (\*4) 15", and (\*4) 18" wide door slabs



### Bi-Parting Barn Door Hardware Kits

This innovative cable-driven synchronizing technology enables the simultaneous opening and closing of bi-parting doors with just one hand. By pulling on one handle, both doors glide open or closed in unison. Add functionality and versatility with this easy-to-install hardware offering.

# Interior Doors

BARN DOOR KITS



## RENIN

### Complete Barn Door Kits

Renin's Barn Door Kits have everything you need to transform a space and create an instant focal point you'll be proud to share. Available in a variety of designs and finishes to match the style of your home.

Kits include a ready-to-install door with pre-drilled mounting holes, bottom groove guide and matching backer board, matte black hanging hardware and matching handle.



Sierra Barn Door Kit  
*SIER 3/O UP BKBS*



Boca 1 Panel Barn Door Kit  
*BOCA3/O PW BKBS*



Pavilion 5 Lite  
Frosted Barn Door Kit  
*PAV3/O BW BKBS*



Hall 3 Lite Frosted  
Barn Door Kit  
*HALL3/O IA BKBS*



Stone K Barn Door Kit  
Primed White  
*STONE3/O PW BKBS*



Stone K Barn Door Kit  
Silver Oak  
*STONE3/O SO BKBS*

## MIRRORS AND MEDICINE CABINETS



### LED Mirrors

Illuminated mirrors emit directional light at eye level and allow you to avoid the deep shadows cast by overhead lighting. These mirrors offer subtle, soft lighting with luxurious design.



LEFT: Landscape LED Mirror 36" x 32"  
RIGHT: Modena LED Mirror 24" x 32"



### LED Mirror Medicine Cabinets

Combine brightness and functionality to your bathroom with a LED Mirror Medicine Cabinet. Available with single or double doors to easily access your cabinet's contents with adjustable glass shelves.



LEFT: Antica LED Mirror Medicine Cabinet  
RIGHT: Cassini LED Mirror Medicine Cabinet



### Standard Medicine Cabinets

Every bathroom needs a mirror and combining it with additional storage is the perfect solution for your space. Available with single or tri-view doors and adjustable shelves.



LEFT: Ashfield Framed Single Door Medicine Cabinet  
RIGHT: Fairfield Tri-View Mirror Medicine Cabinet



# Common Areas

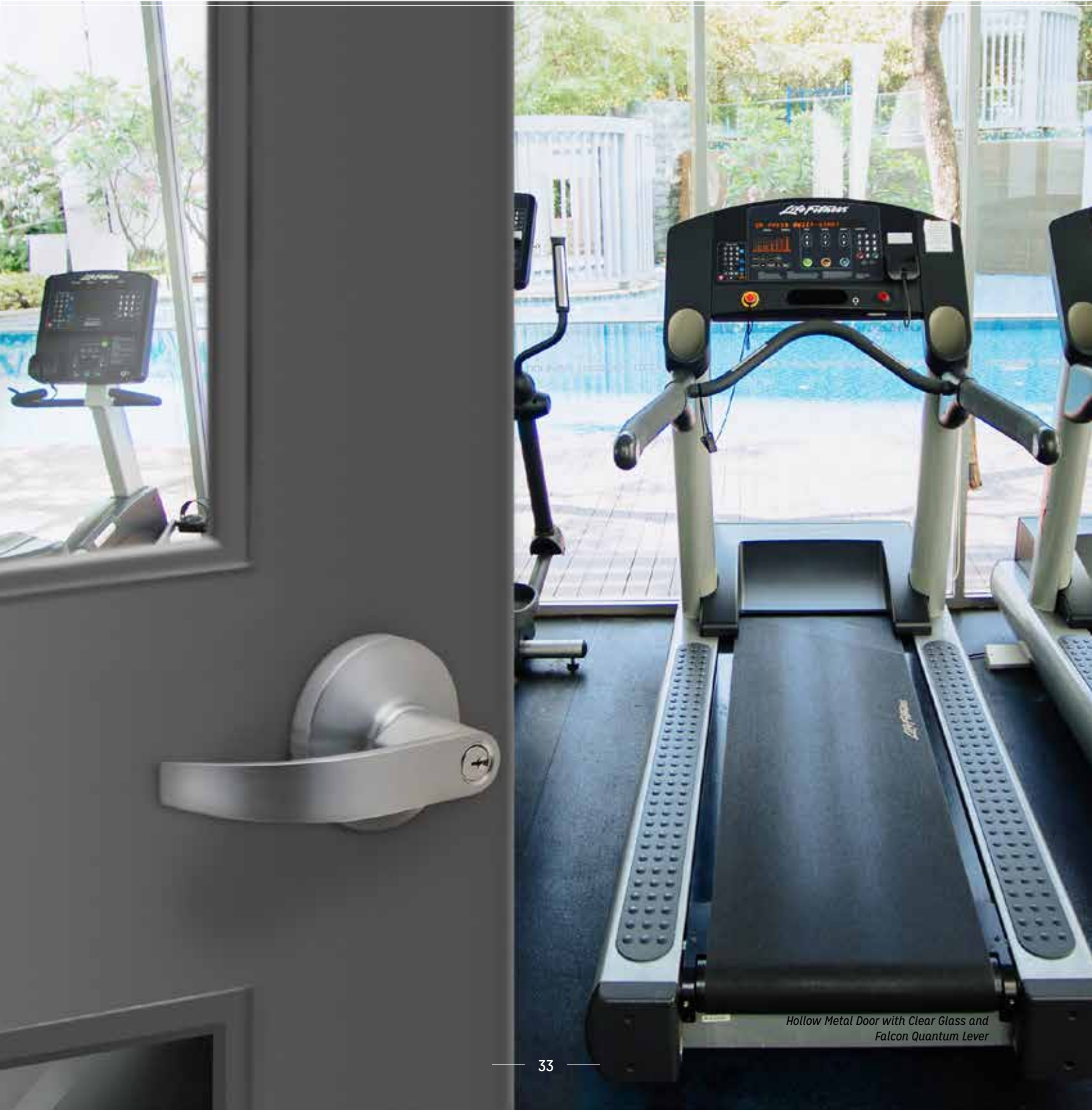

*Hollow Metal Door with Clear Glass and Falcon Quantum Lever*

# Common Areas

 HOLLOW METAL DOORS

## Hollow Metal Doors

**DAYBAR**

Hollow Metal doors are available in 20, 18 or 16 gauge for commercial and industrial usage. Lockseam (LS) doors are made from Galvanneal steel. They are available in honeycomb core for interior use, insulated with polystyrene or polyurethane for exterior applications and sound transmission control. Fire rating to 3 hours. Also available with temperature rise core.

**Widths** 2/0 to 3/0, in 2-inch increments as standard, 3/6, 4/0

**Heights** 6/8 or 7/0, in 2-inch increments as standard.

Maximum sizes for double doors: 8/0 x 8/0.

*Custom, non-standard and oversize also available.*

### Glazing Options

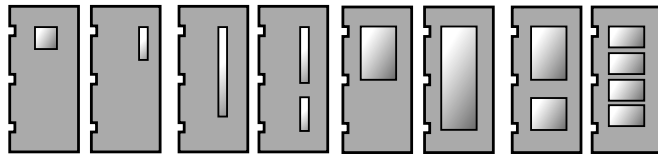

### Decorator Options

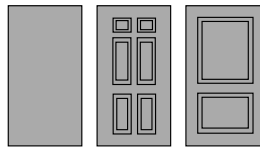

Flush    6 Panel    2 Panel

**Up to 90  
minute fire  
rating**

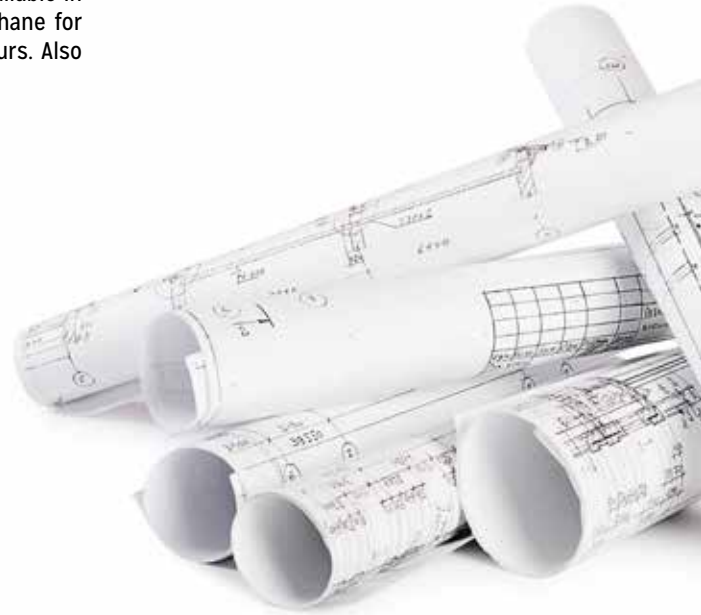

## Welded Special Purpose Frames

**Engineered Frames** can be supplied to suit any opening. Available in a wide range of sizes, configurations and jamb depths to suit most wall conditions.

***No matter how unique your project, we can help. Talk to one of our sales associates to learn more about our wide variety of special order products.***

## Locksets & Hardware

Heavy duty devices, commercial locksets and luxurious architecturally designed hardware to meet every specification.





## BUILDING SPECIALTIES





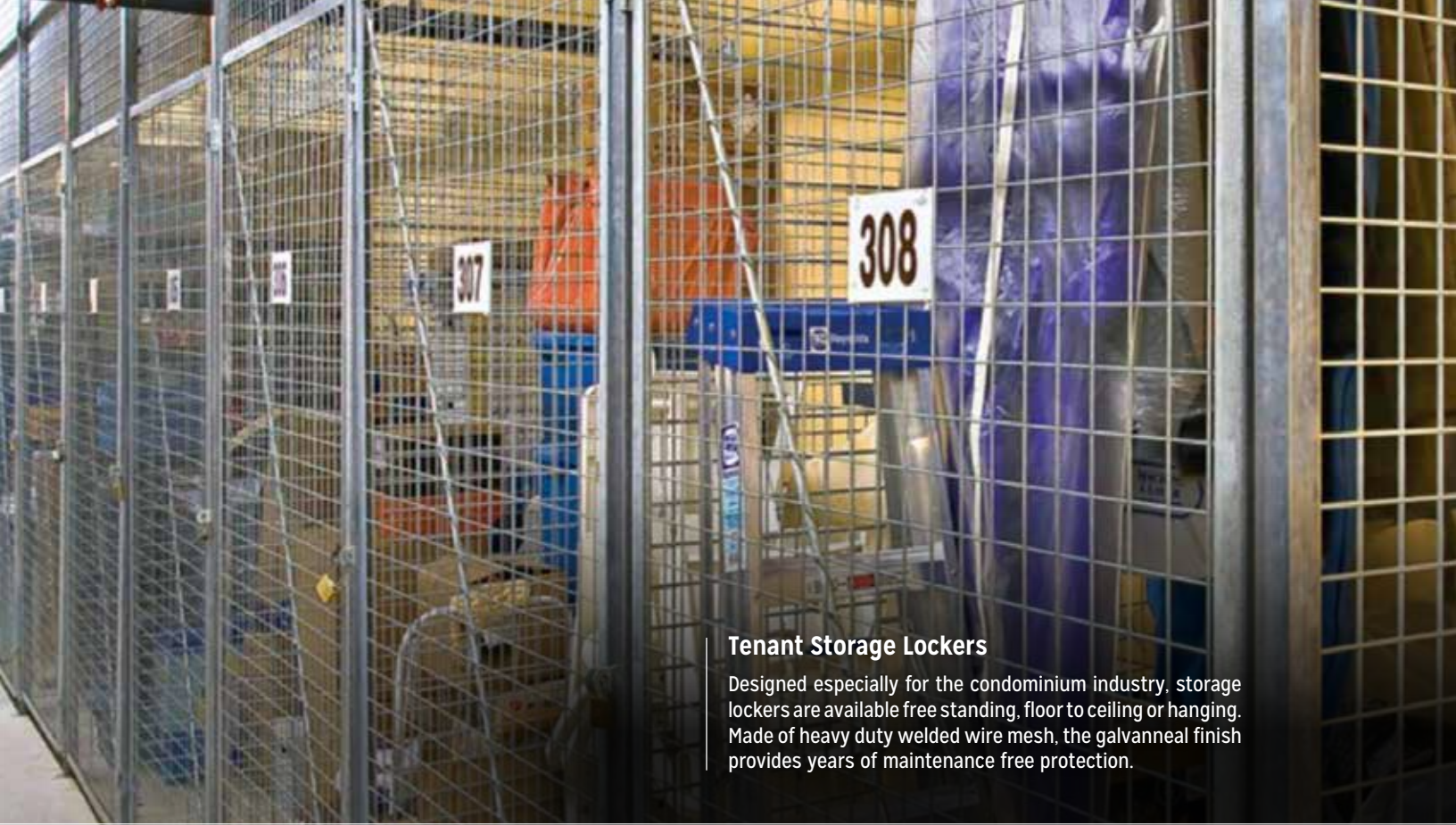

### **Tenant Storage Lockers**

Designed especially for the condominium industry, storage lockers are available free standing, floor to ceiling or hanging. Made of heavy duty welded wire mesh, the galvanneal finish provides years of maintenance free protection.

## BUILDING SPECIALTIES



### **Access Doors & Hatches**

Our roof hatch product offering includes a complete line of roof access and safety products.





**hadrian**<sup>®</sup>

### Hadrian Lockers and Benches

Hadrian's unique locker design features a rigid double-pan, honeycomb reinforced door, full height piano hinge, durable powder coated finish and many other intelligent features to ensure they will look and perform great in any facility.

## BUILDING SPECIALTIES

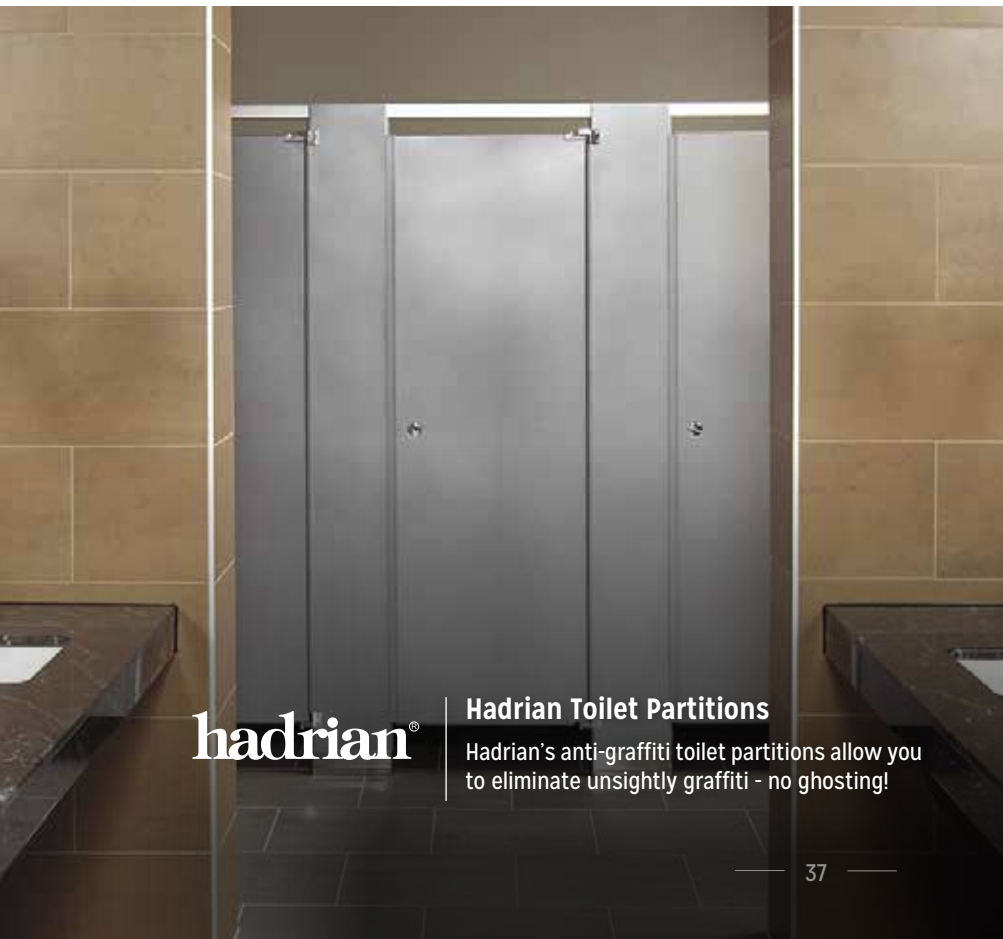

**hadrian**<sup>®</sup>

### Hadrian Toilet Partitions

Hadrian's anti-graffiti toilet partitions allow you to eliminate unsightly graffiti - no ghosting!



**Floor Mounted**



**Floor to Ceiling**



**Ceiling Mounted**



**Headrail Braced**



### **Garbage and Laundry Chutes**

Fire-rated standard chute doors for garbage, linen or recycling systems.



## BUILDING SPECIALTIES



### **Mailboxes**

Vertical or horizontal, recessed wall mounted mailboxes.







### **Bike Racks**

Available in different lengths, colours, finishes and sizes to securely and safely store bicycles.



## BUILDING SPECIALTIES



### **Balcony and Storage Doors**

Available with either a steel or fiberglass door. Maintenance-free and factory finish options are available.





Madero, a distributor and vendor since 1987, offers a full line of architectural hardware, commercial hollow metal doors and frames, building accessories and specialty products. With access to a wide variety of products from industry-leading manufacturers, Madero is able to source the necessary materials for your next building project. Whatever the project, large or small, trust the professionals at Madero to assist in the process and ensure you receive the right products for the task at hand.



Entry Doors



Garden Patio Doors



Artisan Doors



Interior Doors



Larson Product Catalogue



Commercial

Contact us at:

[madero.ca](http://madero.ca) | [canada.orders@madero.ca](mailto:canada.orders@madero.ca) | 1.800.667.6977

  @maderocanada

Printed & designed by

